

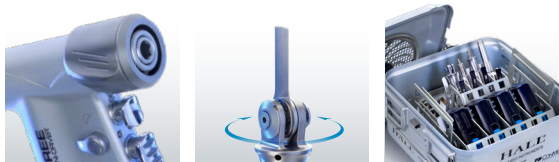

# HALL® Powered Instruments System

Product Catalog



**HALL® MICROPOWER+**  
SMALL BONE HANDPIECE



**HALL® MICRO 100™**  
SURGAIRTOME TWO

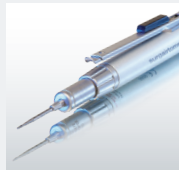

**M-CLASS™**  
BLADES



**HALL® LITHIUM**  
BATTERIES



**HALL®**  
POWERED INSTRUMENTS

Ordering Information.....	2	Attachments & Bur Guards .....	47
Product Support .....	3	For Use with Micro Handpieces .....	
Warranty Terms.....	4	Sterilization Trays.....	48
Return/Repair Information.....	5	For Use with Micro Handpieces .....	
HALL® Titan®.....	6	Micro Sagittal Saw Blades .....	49- 54
Indications for Use: Large Bone & Small Bone Orthopedics .....		Micro Oscillating Saw Blades .....	55-57
HALL® 50 .....	7	Micro Reciprocating Saw Blades & Rasps.....	58
Indications for Use: Large Bone & Small Bone Orthopedics .....		Micro Burs .....	59-61
Batteries & Accessories .....	8, 9	Sternum Saws.....	62
PowerPro® & PowerPro Electric II™ .....	10	Sternum Saw Blades .....	63-65
Indications for Use: Large Bone & Small Bone Orthopedics .....		Indications for Use: Primary & Repeat Sternotomy .....	
PowerPro® Pneumatic .....	11	Ultrapower® .....	66, 67
Indications for Use: Large Bone & Small Bone Orthopedics .....		Indications for Use: Spine & Neuro .....	
Pin and Wire Drivers.....	12	UltraPower Burs .....	68-71
Indications for Use: Large Bone & Small Bone Orthopedics .....		Indications for Use: Otolaryngology (Round Burs Only), Spine & Neuro .....	
Attachments.....	13	E9000® System .....	72
Indications for Use: Large Bone & Small Bone Orthopedics .....		Indications for Use: ENT, Spine & Neuro .....	
Sterilization Trays.....	14	E9005 ENT Shaver Blades.....	73-76
Indications for Use: Large Bone Orthopedics .....		Indications for Use: Sinus Surgery .....	
HALL® Pro Blades.....	15-17	E Burs.....	77, 78
Intrex® Blade System.....	18	Indications for Use: Otolaryngology, Spine & Neuro .....	
Indication for Use: Total Knee Arthroplasty .....		Osteon™ .....	79
M-Class® Blades.....	19	Indications for use: ENT .....	
Indication for Use: Total Knee Arthroplasty .....		Osteon™ Burs .....	80
HALL® Classic Blades .....	20	Indications for use: Otolaryngology .....	
Indication for Use: Total Knee Arthroplasty .....		Cebotome® .....	81
Large Bone Knee Blades.....	21-31	Indications for use: Large Bone Revision Surgery.....	
Indication for Use: Total Knee Arthroplasty .....		Cebotome® Burs & Metal Cutting Accessories.....	82
Stryker® Compatible Replacement Blades .....	32, 33	Indication for Use: Large Bone Revisions Surgery .....	
Large Bone Oscillating Blades.....	34, 35	Wires & Staples.....	83
ACL Blades .....		Indication for Use: Small Bone Trauma .....	
Large Bone Oscillating Blades .....	36-39	Miscellaneous Accessories .....	84
Indications for Use: Total Joint Arthroplasty & Large Bone Trauma .....		Electric Consoles & Accessories.....	85, 86
Large Bone Reciprocating Blades.....	40, 41	Pneumatic Regulators, Hoses & Accessories .....	87
Indications for Use: Total Joint Arthroplasty & Large Bone Trauma .....		Kit Listings .....	88-91
HALL® MicroFree™ Power System .....	42, 43		
Indications for Use: Small Joint .....			
MicroPower™ + .....	44		
Indications for Use: Small Bone .....			
MicroPower® .....	45		
Indications for Use: Small Bone .....			
Micro 100™ .....	46		
Indications for Use: Small Bone .....			

## Terms

CONMED standard terms are net thirty (30) days, F.O.B. shipping point, unless otherwise approved in writing by CONMED. All orders and transactions are subject to the laws of the state of Florida.

## To Place Your Order

Please provide a purchase order number, billing and shipping instructions, product catalog number and description, valid CONMED quotation, and quantity and pricing to one of the following:

### Your Sales Representative

### Customer Service

Phone: 800-237-0169

Fax: 727-399-5256

E-mail: [custserv1@CONMED.com](mailto:custserv1@CONMED.com)

### CONMED

Attn: Customer Service

11311 Concept Boulevard

Largo, FL 33773-4908 USA

## True Purchasing Flexibility

CONMED Financial Services offers a variety of flexible financing programs, from leases to Pre-Procedure Programs to delayed payment plans. Ask your Sales Representative for more information on how you can acquire the latest technology through a financing program that fits your unique budgetary requirements.

## Rental Program for Instrument Sets & Capital Equipment

In every O.R., there are times when you have to schedule a case but do not have the equipment needed. Either the capital funding for the equipment has yet to be approved or you have been unable to justify the cost of the equipment due to the procedure's low volume.

For these situations, CONMED offers a rental program for procedure-specific instruments and capital equipment. Simply call CONMED at 888-587-9742 and everything that you need for the case is on its way.

To enroll in a rental program, contact your Sales Representative or call the CONMED field inventory team. Your representative will help you customize the kit(s) to fit your procedural requirements. After the case, simply return the instruments, cleaned and sterilized if appropriate, along with any disposables you did not use. The rental fee will be billed for the disposables not returned, and customer will be responsible for any expedited shipping cost.

Failure to return instrumentation/equipment at the end of the rental period will result in the customer being charged the standard rental fee automatically for each week that the instrumentation/equipment is not received by CONMED.

At CONMED, we want to offer more than a quality product. We take pride in being able to provide you with value added services to support our products. The information given in this catalog is designed to address your questions regarding product support.

## Customer Support

If you encounter a problem or need technical assistance, contact Customer Service (Product Support) or your Sales Representative. Refer to the Customer Service telephone numbers listed on page 2.

## Regulatory Compliance

Report any injuries or malfunctions to CONMED Customer Service. Refer to the Customer Service telephone numbers listed on page 2.

## Original Warranty

CONMED (the "Company") warrants to the first purchaser or lessee ("You" or "Customer") that the instruments, attachments and parts manufactured by or for the Company (hereinafter collectively "Instruments") have been tested, inspected, and shipped in proper working order.

The Company warrants all new instruments to be free from defects in materials and workmanship for the following periods, measured from date of sale\*:

Product Categories	Months
All Single Use Products.....	Upon Receipt
Powered Surgical Instruments.....	12
Power Attachments and Accessories.....	12
Handpiece Cords and Power Cords .....	6
Pneumatic Hoses .....	6
Bur Guards, Blade Guards, Attachments .....	6
Battery Packs, Power Units and Accessories .....	3
Battery Chargers .....	12
Camera Consoles .....	12
Video Components .....	12
Video Cables and Light Guides.....	3
Scopes .....	12
Camera Heads .....	12
Instruments.....	12
Instrument Trays.....	3
Footswitches .....	12
Irrigation Systems (Pumps and Remotes).....	12
Reusable Procedure Specific Instruments.....	6

Following the Original Warranty, CONMED offers SHIELD Service Programs that support our products throughout their lifetime. Service programs address the necessity to control cost and greatly reduce repair turnaround time. Products not covered under a service program are subject to variable repair charges. To find out which service option best meets your needs, contact your local Sales Representative.

## Service Agreements

Service Agreements provide additional service coverage on capital equipment. This additional warranty period covers all repair costs, periodic maintenance, free loaner usage during repair time and freight charges out from CONMED both on the loaner product and the repaired instrument.

## Service Warranty

After expiration of the original warranty period, instruments may be returned to CONMED for repair at the customer's expense. CONMED warrants that any service or repair work performed by CONMED SHALL be free from defects in workmanship and materials for a period of 90 days after the date the customer receives the Instrument(s). This limited warranty applies only to the actual service or repair work performed by CONMED or its authorized service centers. CONMED warrants that all parts and assemblies used in the repair or service of Instruments meet new part functional specifications, although some parts or assemblies may have been remanufactured.

CONMED components are manufactured to exacting tolerances and design specifications. As a standard practice, all repairs are subject to strict product performance and testing specifications prior to returning the Instrument to the customer. CONMED ensures that each Instrument is inspected according to the guidelines used for new manufactured Instruments. If an Instrument is determined unrepairable, CONMED will offer to sell to the customer a refurbished or brand new Instrument or comparable equivalent at a preferential price. All parts and assemblies replaced by CONMED SHALL become the property of CONMED.

### Minimum Service Charge

There is a minimum repair charge for the evaluation and testing of all returns (except for products covered under warranty).

### Return Shipping

All repaired products will be returned to you via second day air delivery unless you request an alternate shipping method. The cost of return shipping is your responsibility unless the product is under warranty or service agreement.

\* Effective February 1, 2014

## Warranty Terms

If the customer discovers within the original warranty period that an Instrument has a defect in materials and/or workmanship, the customer must promptly notify the Company. Also, if the customer discovers within the service warranty period that any service or repair work performed by CONMED has a defect in workmanship and/or materials, the customer must promptly notify the Company. If it becomes necessary to return the Instrument to the Company, the customer must (a) acquire a "Service Request" (SR) authorization from the Company Customer Service Department, (b) pack the unit carefully, and (c) return it to the Company.

Within a reasonable time after receipt of the Instrument, the Company will investigate and correct any defect covered by warranty by providing, at its option, one of the following: service or repair of the Instrument, or replacement of the Instrument. All parts and assemblies replaced by CONMED SHALL become the property of CONMED. These remedies are the customer's exclusive remedies under the warranty.

### The foregoing limited warranties do not apply to:

- » Instruments that have been tampered with, altered, neglected, or misused
- » Instruments damaged through use with other than Company authorized accessories, attachments, burs or blades
- » Instruments not manufactured by or for the Company
- » Instruments used for purposes other than those for which they were designed and manufactured, including use in any way inconsistent with the instructions and warnings contained in the Company instruction manuals and package inserts
- » Instruments that were last serviced, refurbished, reprocessed or reconditioned by a nonauthorized service entity

**THE FOREGOING LIMITED WARRANTIES ARE IN LIEU OF ALL OTHER WARRANTIES, EXPRESS OR IMPLIED, INCLUDING, BUT NOT LIMITED TO, THE IMPLIED WARRANTIES OF MERCHANTABILITY AND FITNESS FOR A PARTICULAR PURPOSE.**

In no case shall the Company be liable for any special, incidental, indirect or consequential damages based upon breach of warranty or any other legal theory. Some jurisdictions do not allow limits on warranties, or on remedies, and, in such jurisdictions, the limits in this and the preceding paragraphs may not apply.

The Company reserves the right (a) to make design changes to Instruments at any time without notice to customer and without incurring any obligation to incorporate those changes into Instruments previously purchased or leased, and (b) to make changes from time to time in the contents of any publication, instruction manual or package insert without any obligation to notify customers of such revisions or changes, and (c) to change price without notice.

## U.S. Procedure for Returns/Repairs

1. All Instruments must be cleaned and decontaminated, if appropriate, prior to return of any Instrument to CONMED. Instruments contaminated with biohazardous materials will be returned to you at your expense.
2. An authorized Service Request (SR) Number must be obtained prior to returning any Instrument for repair/return.
3. To return a product for repair, contact CONMED Customer Service. The following information is needed to process a repair/return:
  - » Catalog Number
  - » Serial/Lot Number
  - » Original Invoice Number
  - » Detailed description of the problem or reason for return
4. The SR number must be displayed on the outside of the box, included with all paperwork, and must be referred to when making an inquiry about the status of a repair/return.
5. CONMED maintains various repair centers around the world. When you are issued your SR number, you will be advised of the location where to send your product.

## Return Terms

If it becomes necessary to return a product after purchase, the product must be returned within 45 days of its ship date. The product must be returned unused, in the original packaging and be restockable. Returns must be shipped prepaid freight. Returns that are not shipped prepaid freight will not be accepted. All product returns, except those attributable to a CONMED error, are subject to a restocking fee of 15% of the purchase price or \$25, whichever is greater.

### Products Not Eligible for Credit:

- » Sterile products/single use devices returned with the outer packaging seals broken
- » Non-sterile products that have been sterilized and/or placed in the surgical field
- » Products damaged by customer misuse or negligence
- » Altered or customized products
- » Products damaged in return transit due to inadequate packaging
- » Less than full packages – all products must be in original packaging
- » Obsolete products

### Packaging

Whenever it is required to return your product, be sure to package it in a protective carton. We recommend that you save the original shipping container for this purpose. In-transit damage is not covered by the warranty; therefore, it is best to always insure shipments.

# HALL® TITAN®

Indications for Use: Large Bone  
& Small Bone Orthopedics



# HALL® 50™

Indications for Use: Large Bone  
& Small Bone Orthopedics



PRO9100B

PRO9200B

Attachments Listed on Pages 12 and 13

Cat. No.

Hall® Titan® 1-Trigger Modular Drill .....	PRO9100B
Hall® Titan® 2-Trigger Modular Drill .....	PRO9200B



PRO9300B

PRO9305B

Hall® Titan® Oscillating Saw .....	PRO9300B
Hall® Titan® Primecut+™ Oscillating Saw .....	PRO9350B



PRO9400B

PRO450B

Hall® Titan® Reciprocating Saw .....	PRO9400B
Hall® Titan® Sternum Saw .....	PRO9450B

Attachments Listed on Pages 12 and 13

Cat. No.

HALL® 50™ 1-Trigger Modular Handpiece.....	PRO7100B
HALL® 50™ 2-Trigger Modular Handpiece .....	PRO7200B



PRO7100B

PRO7200B

HALL® 50™ Oscillating Saw Handpiece .....	PRO7300B
---	----------



PRO7300B

HALL® 50™ Reciprocating Saw Handpiece .....	PRO7400B
---	----------



PRO7400B

All products may not be available in all markets.

All products may not be available in all markets.



L3000

HALL® Lithium Charger ..... Cat. No. L3000



L3000SM

L3000LG

HALL® Large Lithium Battery, 13.2 Volt..... L3000LG  
 HALL® Small Lithium Battery, 13.2 Volt..... L3000SM



PRO3600

NiCad Battery Charger ..... PRO3600



PRO3010



PRO3011

Large NiCad Battery, 9.6 Volt..... PRO3010  
 X-Large NiCad Battery, 12 Volt..... PRO3011

Small NiMH Sterile Transfer Battery, 12 Volt ..... PRO3520  
 Large NiMH Sterile Transfer Battery, 9.6 Volt..... PRO3115

Cat. No.



PRO3520



PRO3115

Battery Case for PRO3520 ..... PRO3521  
 Battery Case for PRO3115 ..... PRO3110



PRO3521



PRO3110

Transfer Shroud for PRO3521 ..... PRO3531  
 Transfer Shroud for PRO3110 ..... PRO3130



PRO3531



PRO3130

Charging Platform for PRO3520..... PRO3535  
 Charging Platform for PRO3115 ..... PRO3135



PRO3535



PRO3135

# PowerPro® & PowerPro Electric II™

Indications for Use: Large Bone  
& Small Bone Orthopedics



# PowerPro® Pneumatic

Indications for Use: Large Bone  
& Small Bone Orthopedics



**PRO6100**

Attachments Listed on Pages 12 and 13

**Cat. No.**

PowerPro® Electric II 1-Trigger Modular Handpiece..... PRO6100

Attachments Listed on Pages 12 and 13

**Cat. No.**

PowerPro® Pneumatic Single Trigger Modular Handpiece..... PRO6150



**PRO6150**



**PRO6125**

PowerPro® Electric II Oscillating Saw..... PRO6125

PowerPro® Pneumatic Oscillating Saw..... PRO6175



**PRO6175**



**PRO6135**

PowerPro® Electric II Reciprocating Saw..... PRO6135

PowerPro® Pneumatic Reciprocating Saw..... PRO6185



**PRO6185**

All products may not be available in all markets.

All products may not be available in all markets.

# Pin and Wire Drivers

Indications for Use: Large Bone & Small Bone Orthopedics



# Attachments

Indications for Use: Large Bone & Small Bone Orthopedics

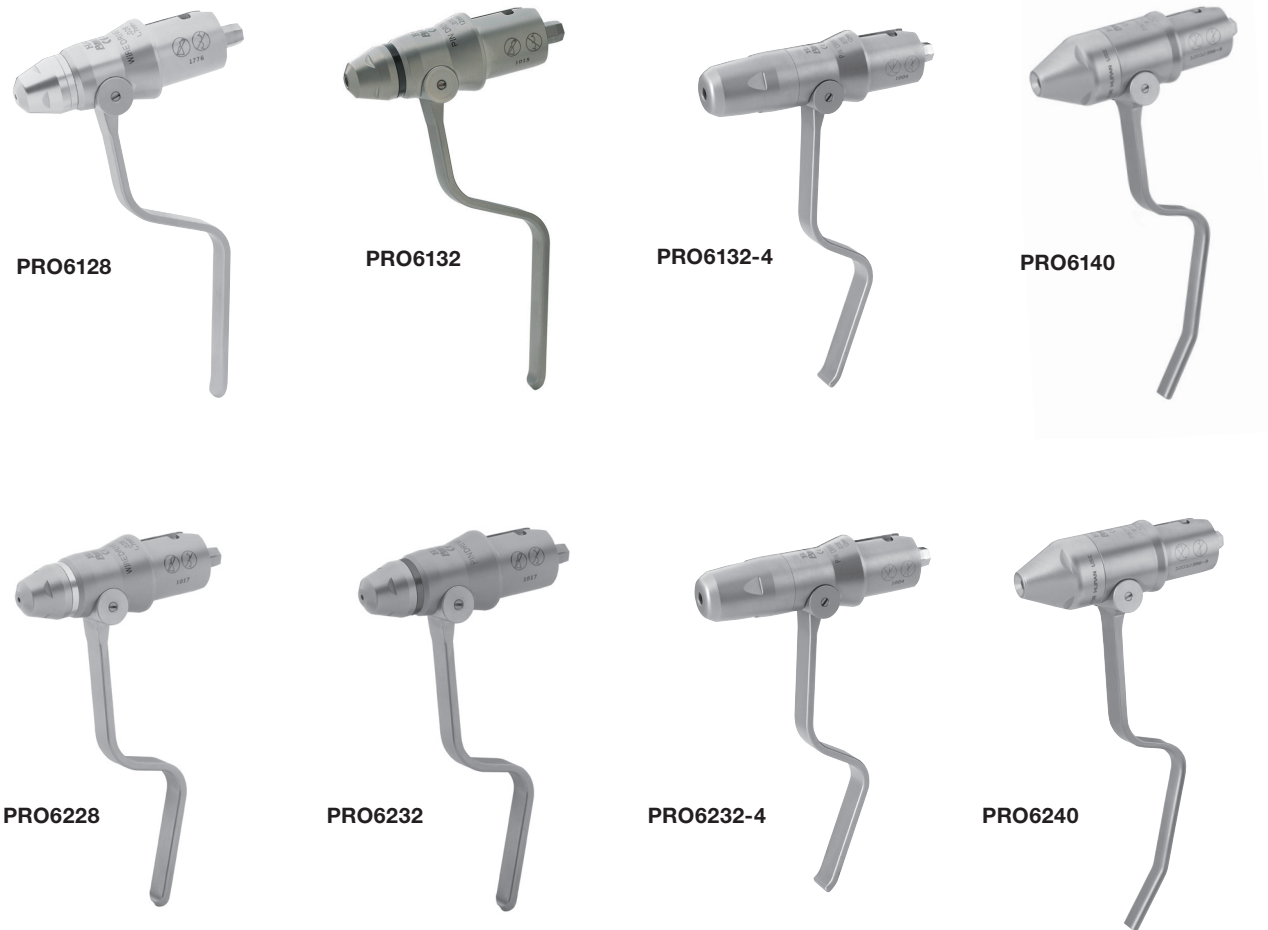

1-Trigger Wire and Pin Drivers		
	Range	Cat. No.
Wire Driver	0.7 – 1.6mm (0.028 – 0.062")	PRO6128
Pin Driver	2.0 – 3.2mm (0.078 – 0.125")	PRO6132
Pin Driver	2.0 – 4.0mm (0.078 – 0.156")	PRO6132-4
Pin Driver	1.8 – 4.0mm (0.071 – 0.157")	PRO6140
2-Trigger Wire and Pin Drivers		
Wire Driver	0.7 – 1.6mm (0.028 – 0.062")	PRO6228
Pin Driver	2.0 – 3.2mm (0.078 – 0.125")	PRO6232
Pin Driver	2.0 – 3.2mm (0.078 – 0.125")	PRO6232-4
Pin Driver	1.8 – 4.0mm (0.071 – 0.157")	PRO6240

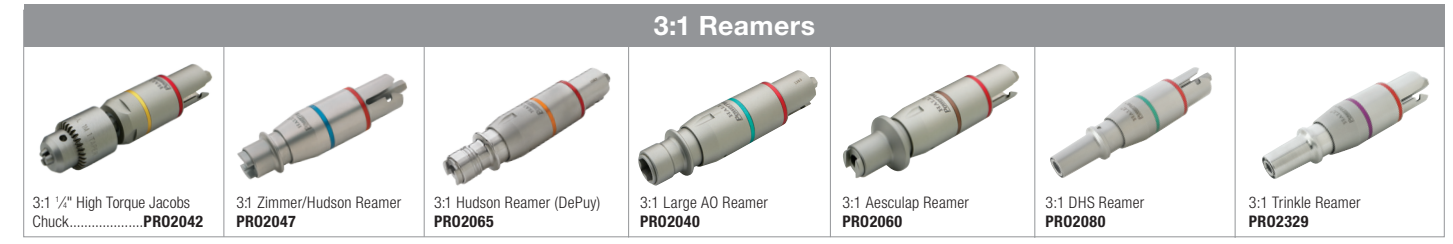
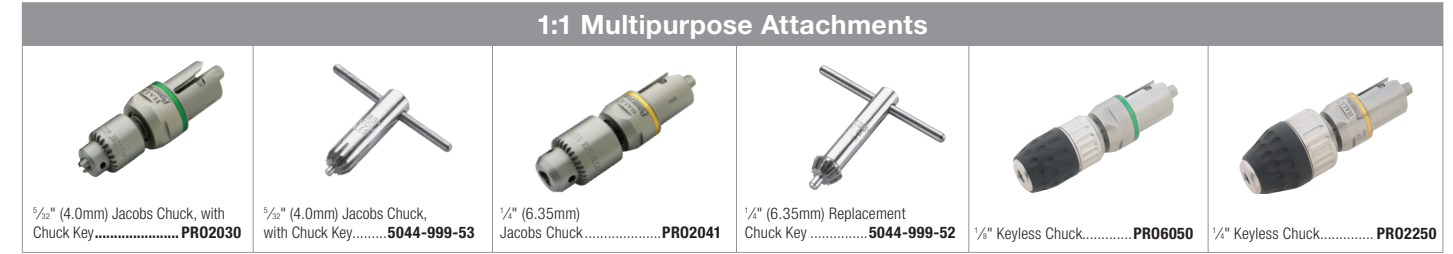



# Sterilization Trays

Indications for Use: Large Bone Orthopedics



# HALL® Pro Blades

Indication for Use: Total Knee Arthroplasty

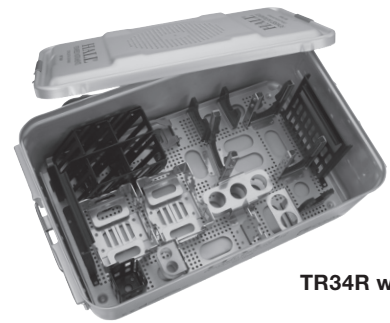

TR34R with PRO7000T



TR34R with PRO7001T, and PRO7002T



TR12R with PRO7001T



TR12R with PRO7002T

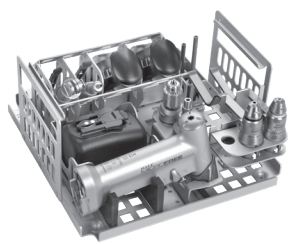

PRO8001T

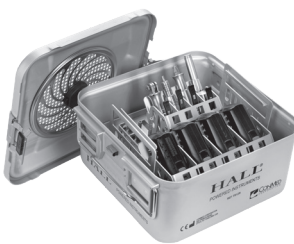

TR12R with PRO8003T

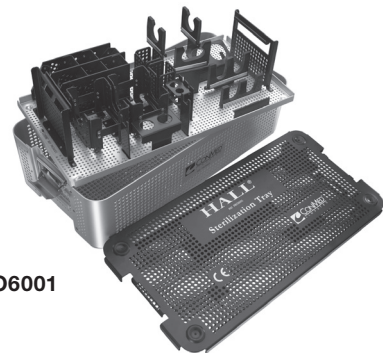

PRO6001

## HALL® Sterilization Containers/Inner Trays

	Cat. No.
¾ Size Rigid Sterilization Container .....	TR34R
½ Size Rigid Sterilization Container .....	TR12R

## HALL® Sterilization Inner Trays

¾ Size Inner Tray, Full Set .....	PRO7000T
½ Size Inner Tray, Drill Set .....	PRO7001T
½ Size Inner Tray, Saw Set .....	PRO7002T
½ Size Inner Tray, Drill Set .....	PRO8003T
½ Size Inner Tray, Drill Set with Mini-Driver .....	PRO8001T

MPower® 2, Large Bone Tray with Battery Holders .....PRO6001

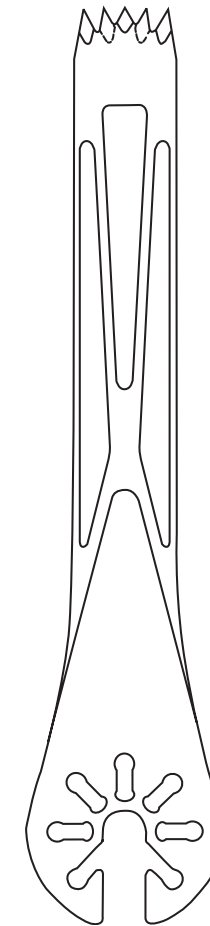

5071-582



5071-263



5071-262

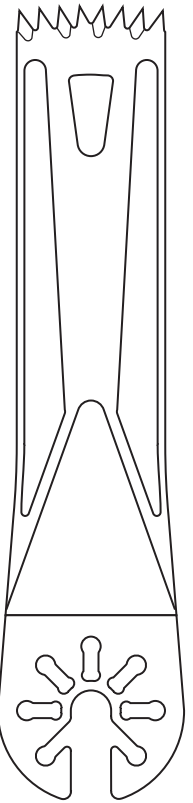

5071-185

Blade images are 1:1 in length and width.

**BOLD** =Chromium Coated

Body Width	13.0mm	14/8mm	14.0mm	14.0mm	19.5mm
Length	90.0mm	75.0mm	75.0mm	90.0mm	80.0mm
<b>Thickness</b>	<b>Blade Catalog #</b>				
0.09mm					5071-185 <b>5071-195</b>
1.19mm		<b>5071-263</b>		<b>5071-261</b>	
1.27mm	5071-582	<b>5071-264</b>	<b>5071-262</b>		
1.37mm		<b>5071-265</b>			

# HALL® Pro Blades

Indication for Use: Total Knee Arthroplasty



# HALL® Pro Blades

Indication for Use: Total Knee Arthroplasty

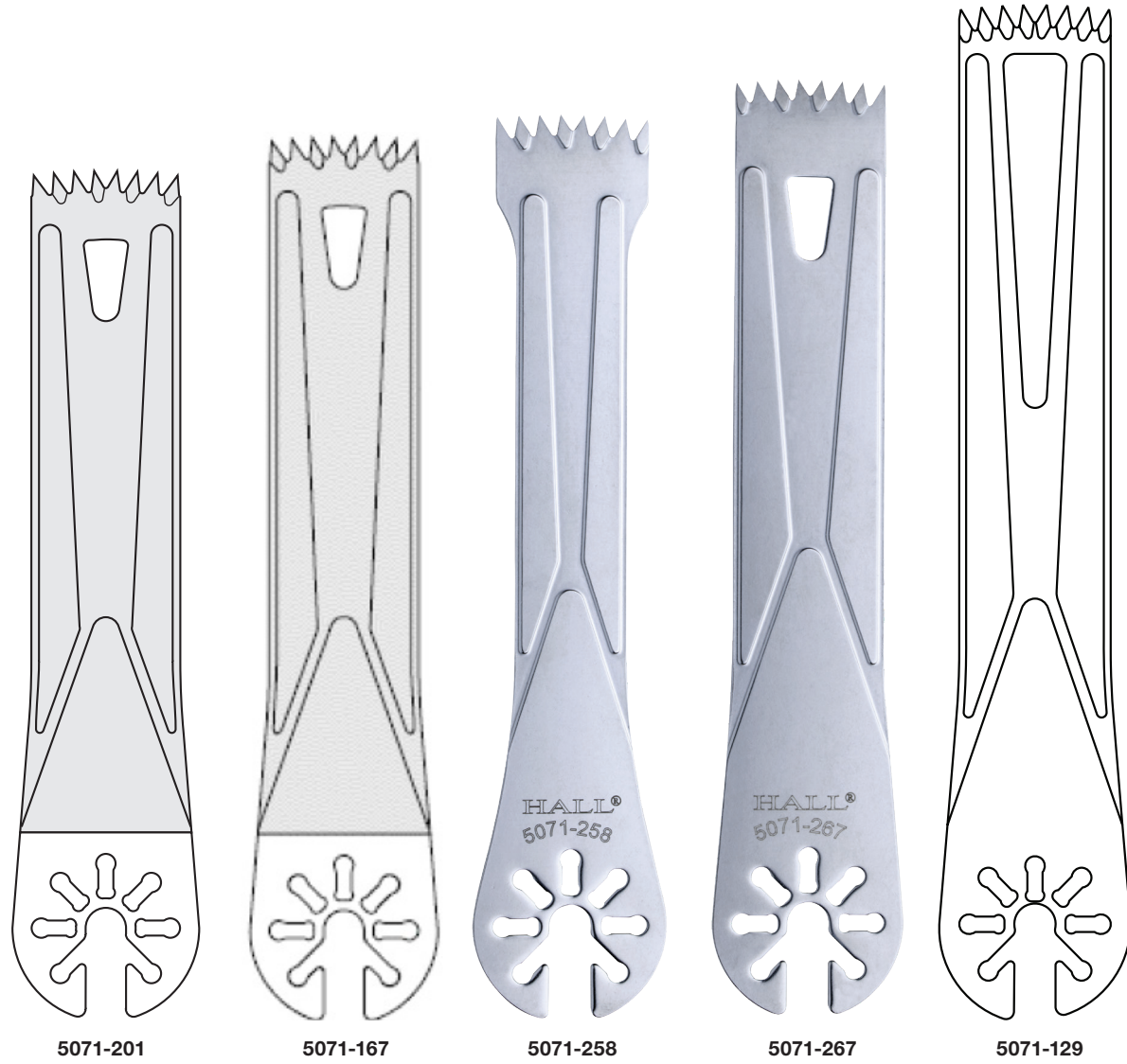

5071-201

5071-167

5071-258

5071-267

5071-129

Blade images are 1:1 in length and width.

**BOLD** =Chromium Coated

Body Width	19.5mm	19.5mm	19.5/14mm	19.5mm	19.5mm
Length	86.0mm	90.0mm	90.0mm	95.0mm	105.0mm
Thickness	Blade Catalog #				
1.19mm			<b>5071-257</b>		
1.20mm		5071-184 <b>5071-167</b>			
1.27mm	5071-181 <b>5071-201</b>		<b>5071-258</b>	5071-123 <b>5071-267</b>	5071-129
1.37mm			<b>5071-259</b>		

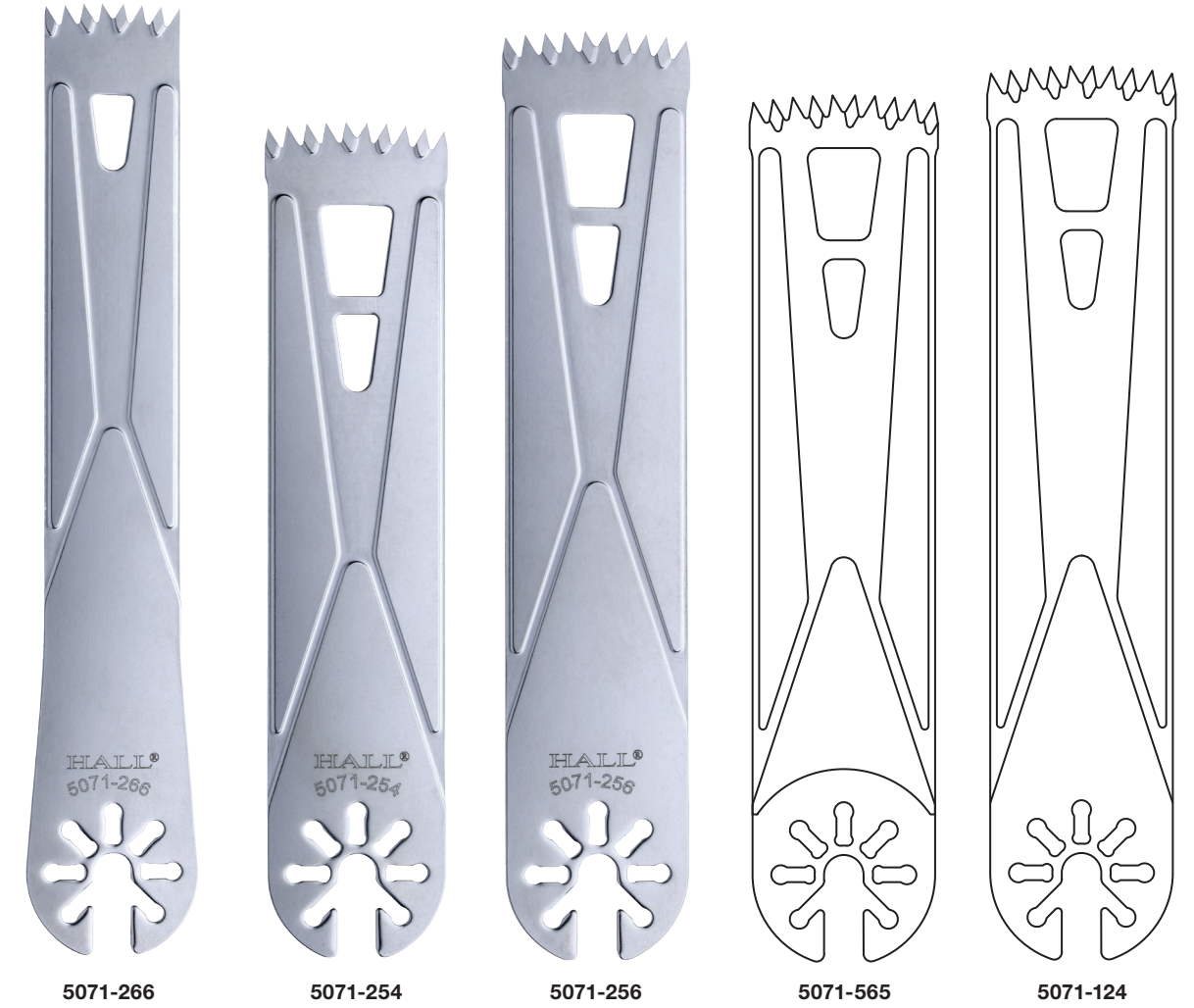

5071-266

5071-254

5071-256

5071-565

5071-124

Blade images are 1:1 in length and width.

**BOLD** =Chromium Coated

Body Width	19.5mm	25mm	25mm	25.4mm	25.4mm
Length	110.0mm	90.0mm	100.0mm	90.0mm	95.0mm
Thickness	Blade Catalog #				
.09mm				5071-196	5071-121
1.0mm				5071-562	
1.19mm		<b>5071-252</b>	<b>5071-255</b>		
1.27mm		<b>5071-253</b>	<b>5071-256</b>	5071-161	5071-124
1.37mm	<b>5071-266</b>	<b>5071-254</b>		5071-163	
1.47mm				<b>5071-565</b>	
1.5mm				<b>5071-144</b>	

# Intrex® Blade System

Indication for Use: Total Knee Arthroplasty



# M-Class® Blades

Indication for Use: Total Knee Arthroplasty

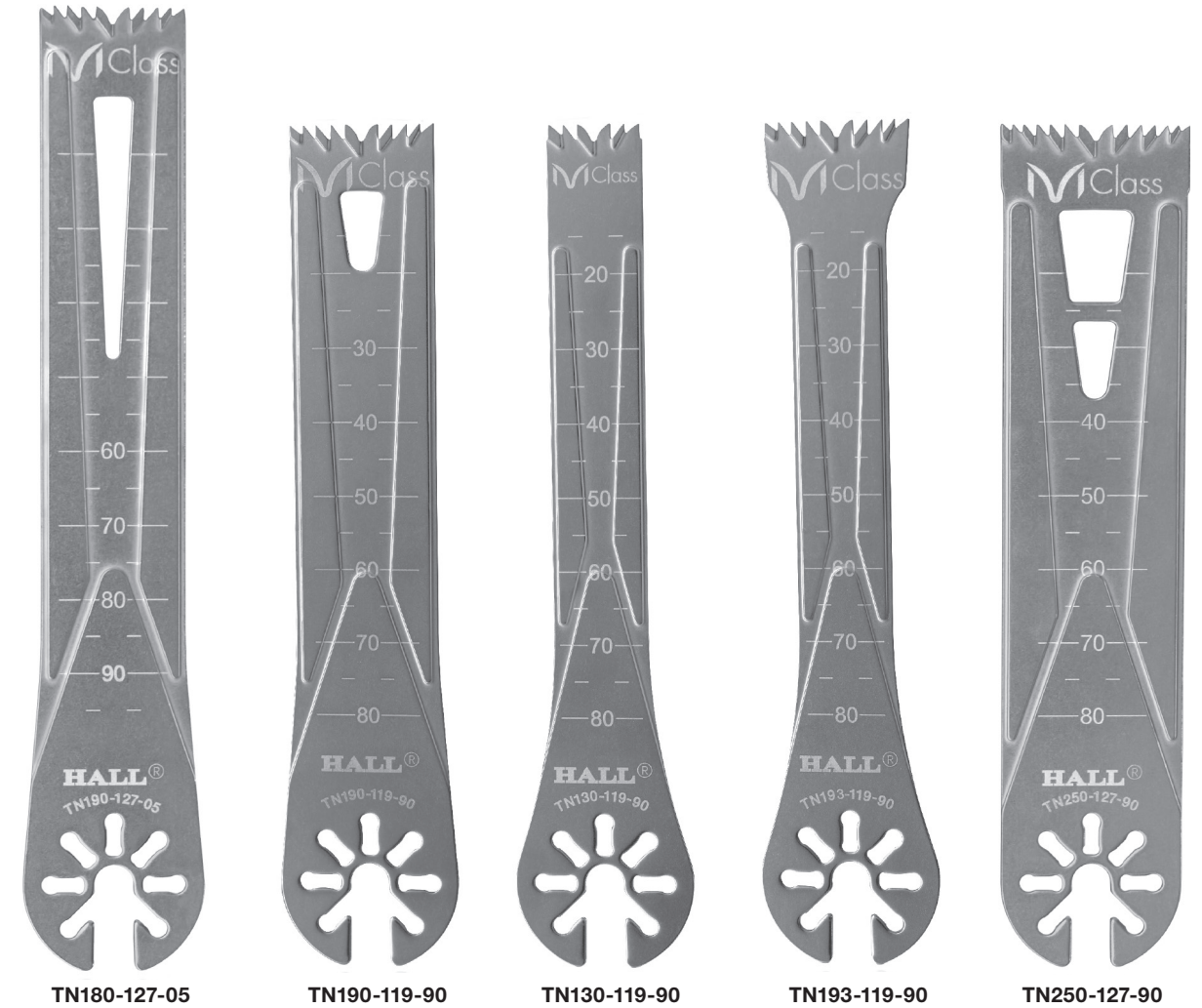
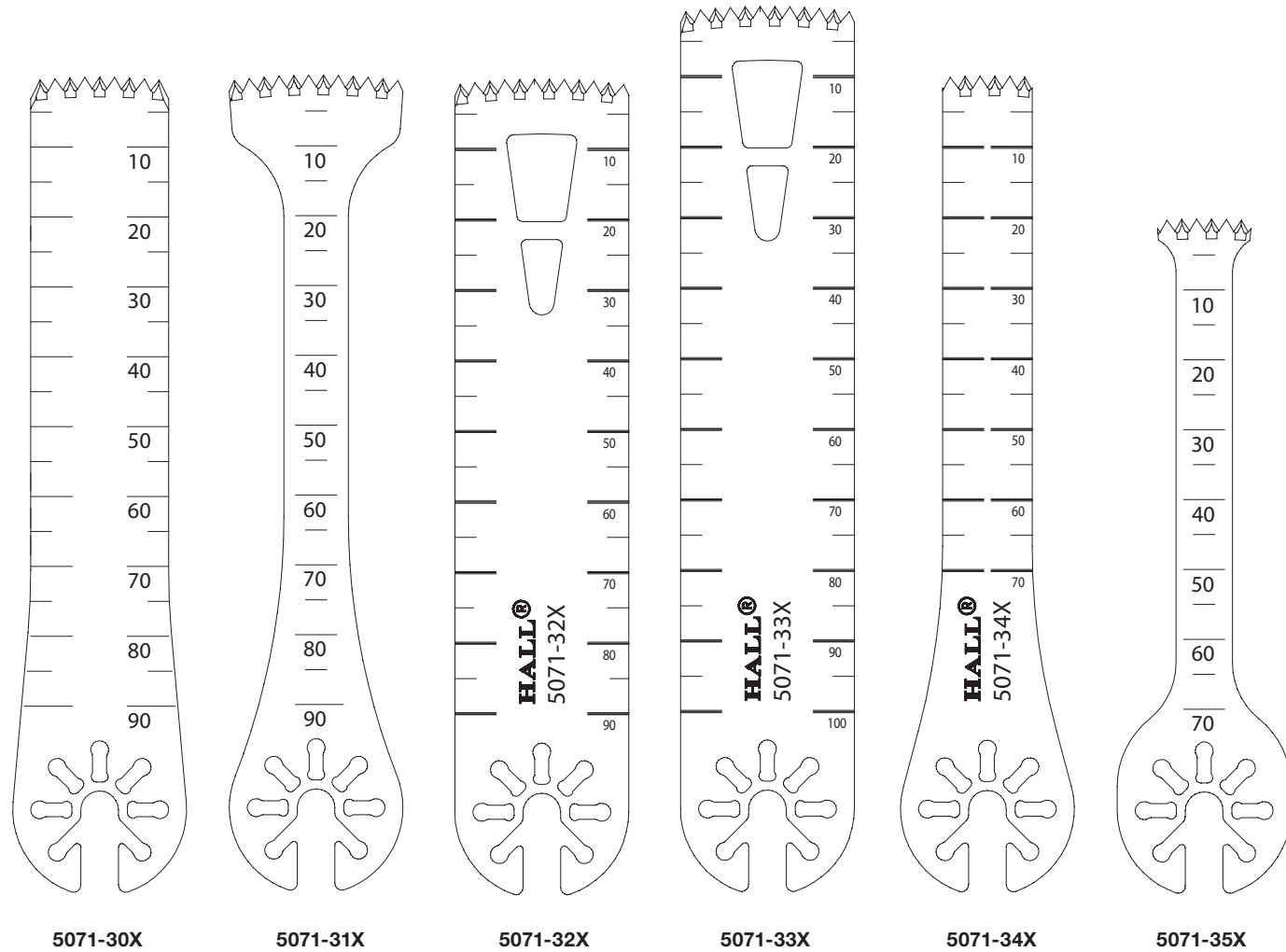

Blade images are 1:1 in length and width.

	Standard	MIS	Standard/ Wide	Standard/Long	Standard / Narrow	Unicondylar
<b>Head Width</b>	19.5mm	25.0mm	25.0mm	25.0mm	12.5mm	13.0mm
<b>Body Width</b>	19.5mm	9.0mm	25.0mm	25.0mm	12.5mm	8.0mm
<b>Length</b>	90.0mm	90.0mm	90.0mm	100.0mm	90.0mm	70.0mm
<b>Thickness</b>	<b>Blade Catalog #</b>					
0.89mm	5071-300		5071-320	5071-330	5071-340	5071-350
1.00mm	5071-301	5071-311	5071-321	5071-331	5071-341	5071-351
1.07mm	5071-302		5071-322	5071-332	5071-342	
1.19mm	5071-303	5071-313	5071-323	5071-333	5071-343	5071-353
1.27mm	5071-304	5071-314	5071-324	5071-334	5071-344	5071-354
1.37mm	5071-305	5071-315	5071-325	5071-335	5071-345	
1.47mm	5071-306	5071-316	5071-326	5071-336	5071-346	5071-356

Blade images are 1:1 in length and width.

	Standard	Standard/ Wide	Standard/Long	Standard / Narrow	Unicondylar
<b>Body Width</b>	19.0mm	19.0mm	13.0mm	19.0/13.0mm	25.0mm
<b>Length</b>	105.0mm	90.0mm	90.0mm	90.0mm	90.0mm
<b>Thickness</b>	<b>Blade Catalog #</b>				
0.89mm		TN190-089-90	TN130-089-90		TN250-089-90
1.00mm		TN190-100-90	TN130-100-90		TN250-100-90
1.07mm		TN190-107-90	TN130-107-90		TN250-107-90
1.19mm	TN190-119-05	TN190-119-90	TN130-119-90	TN193-119-90	TN250-119-90
1.27mm	TN190-127-05	TN190-127-90	TN130-127-90	TN193-127-90	TN250-127-90
1.37mm	TN190-137-05	TN190-137-90	TN130-137-90	TN193-137-90	TN250-137-90
1.47mm		TN190-147-90	TN130-147-90		TN250-147-90

# HALL® Classic Blades

Indication for Use: Total Knee Arthroplasty



# Large Bone Knee Blades

Indication for Use: Total Knee Arthroplasty

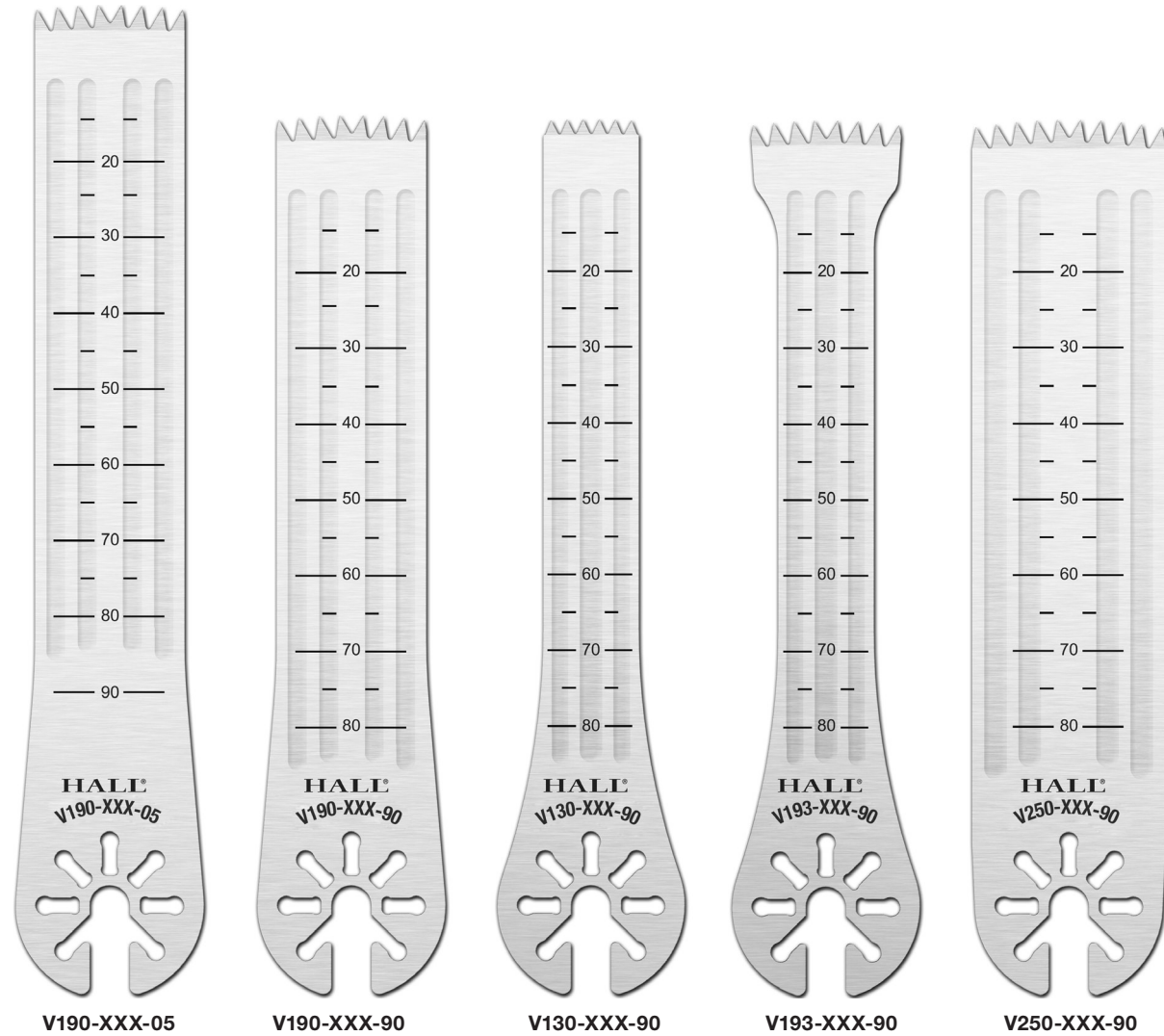

Blade images are 1:1 in length and width.

Body Width	19.0mm	19.0mm	13.0mm	19.0/3.0mm	25.0mm
Length	105.0mm	90.0mm	90.0mm	90.0mm	90.0mm
Thickness	Blade Catalog #				
0.89mm	V190-089-05	V190-089-90	V130-089-90		V250-089-90
1.00mm	V190-100-05	V190-100-90	V130-100-90		V250-100-90
1.07mm	V190-107-05	V190-107-90	V130-107-90		V250-107-90
1.19mm	V190-119-05	V190-119-90	V130-119-90	V193-119-90	V250-119-90
1.27mm	V190-127-05	V190-127-90	V130-127-90	V193-127-90	V250-127-90
1.37mm	V190-137-05	V190-137-90	V130-137-90	V193-137-90	V250-137-90
1.47mm	V190-147-05	V190-147-90	V130-147-90		V250-147-90

## HALL® Blades

Thickness: 0.60mm					
Cat. No.	Width (mm)	Length (mm)	Material Thickness (mm)	Cut Thickness (mm)	
5071-650	49.00	63.00	0.60	0.60	
Thickness: 0.64mm					
5071-594	29.46	58.70	0.64	0.64	
5271-502	29.00	74.00	0.64	0.64	
Thickness: 0.89mm					
5071-528	25.00	73.00	0.89	0.89	
5071-533	21.00	84.50	0.89	0.89	
5071-583	12.70	90.00	0.89	0.89	

# Large Bone Knee Blades

Indication for Use: Total Knee Arthroplasty



# Large Bone Knee Blades

Indication for Use: Total Knee Arthroplasty

## HALL® Blades

Thickness: 0.89mm					
Cat. No.	Width (mm)	Length (mm)	Material Thickness (mm)	Cut Thickness (mm)	
5071-589	13.00	90.00	0.89	0.89	
Thickness: 0.90mm					
5071-532	12.00	80.00	0.90	0.90	
5071-185	19.50	80.00	0.90	0.90	
5071-195	19.50	80.00	0.90	0.90	
5071-146	25.40	90.00	0.90	0.90	
5071-196	25.40	90.00	0.90	0.90	
5071-120	19.50	95.00	0.90	0.90	

## HALL® Blades

Thickness: 0.90mm					
Cat. No.	Width (mm)	Length (mm)	Material Thickness (mm)	Cut Thickness (mm)	
5071-121	25.40	95.00	0.90	0.90	
Thickness: 1.00mm					
5071-562	25.40	90.00	1.00	1.00	
5071-538	25.40	95.00	1.00	1.00	
Thickness: 1.19mm					
5071-548	12.70	86.00	1.19	1.19	
5071-547	25.40	86.00	1.19	1.19	
Thickness: 1.20mm					
5071-167	19.50	90.00	1.20	1.20	
5071-184	19.50	90.00	1.20	1.20	

All products may not be available in all markets.

Grey shaded blades indicate coating.

Grey shaded blades indicate coating.

All products may not be available in all markets.

# Large Bone Knee Blades

Indication for Use: Total Knee Arthroplasty



# Large Bone Knee Blades

Indication for Use: Total Knee Arthroplasty

## HALL® Blades

Thickness: 1.24mm					
Cat. No.	Width (mm)	Length (mm)	Material Thickness (mm)	Cut Thickness (mm)	
5071-558	18.50	73.00	1.24	1.24	
5071-534	25.40	79.50	1.24	1.24	
5071-570-50	25.00	95.00	1.24	1.24	
5071-526	18.50	107.00	1.24	1.24	
Thickness: 1.26mm					
5071-573	18.50	90.00	1.26	1.26	
5071-575	31.00	90.00	1.26	1.26	

## HALL® Blades

Thickness: 1.27mm					
Cat. No.	Width (mm)	Length (mm)	Material Thickness (mm)	Cut Thickness (mm)	
5071-527	19.00	80.00	1.27	1.27	
5071-180	10.00	85.00	1.27	1.27	
5271-580	10.00	85.00	1.27	1.27	
5071-531	25.40	85.00	1.27	1.27	
5071-181	19.50	86.00	1.27	1.27	
5071-201	19.50	86.00	1.27	1.27	
5071-582	13.00	90.00	1.27	1.27	

All products may not be available in all markets.

Grey shaded blades indicate coating.

All products may not be available in all markets.

# Large Bone Knee Blades

Indication for Use: Total Knee Arthroplasty



# Large Bone Knee Blades

Indication for Use: Total Knee Arthroplasty

## HALL® Blades

Thickness: 1.27mm					
Cat. No.	Width (mm)	Length (mm)	Material Thickness (mm)	Cut Thickness (mm)	
5071-161	25.40	90.00	1.27	1.27	
5071-564	25.40	90.00	1.27	1.27	
5271-561	25.40	90.00	1.27	1.27	
5071-590	13.00	95.00	1.27	1.27	
5071-568	16.50	95.00	1.27	1.27	
5071-576	16.50	95.00	1.27	1.27	
5071-123	19.50	95.00	1.27	1.27	

## HALL® Blades

Thickness: 1.27mm					
Cat. No.	Width (mm)	Length (mm)	Material Thickness (mm)	Cut Thickness (mm)	
5071-519	21.00	95.00	1.27	1.27	
5071-124	25.40	95.00	1.27	1.27	
5071-129	19.50	105.00	1.27	1.27	
5071-529	19.50	105.00	1.27	1.27	

# Large Bone Knee Blades

Indication for Use: Total Knee Arthroplasty



# Large Bone Knee Blades

Indication for Use: Total Knee Arthroplasty

## HALL® Blades

Thickness: 1.37mm					
Cat. No.	Width (mm)	Length (mm)	Material Thickness (mm)	Cut Thickness (mm)	
5071-163	25.40	90.00	1.37	1.37	
5071-525	19.00	95.00	1.37	1.37	
5071-530	19.00	95.00	1.37	1.37	
5071-539	25.40	95.00	1.37	1.37	
Thickness: 1.47mm					
5071-565	25.40	90.00	1.47	1.47	
Thickness: 1.50mm					
5071-144	25.40	90.00	1.50	1.50	

## Stryker® Blades

Thickness: 0.64mm					
Cat. No.	Width (mm)	Length (mm)	Material Thickness (mm)	Cut Thickness (mm)	
5072-100	25.00	73.79	0.64	0.64	
5072-150	12.50	73.80	0.64	0.64	



# Large Bone Knee Blades

Indication for Use: Total Knee Arthroplasty



# Large Bone Knee Blades

Indication for use: Total Knee Arthroplasty

## Stryker® Compatible Blades

Thickness: 0.89mm					
Cat. No.	Width (mm)	Length (mm)	Material Thickness (mm)	Cut Thickness (mm)	
5072-109	20.70	85.04	0.89	0.89	
5072-102	24.82	90.47	0.89	0.89	
Thickness: 0.90mm					
5072-195	19.50	80.00	0.90	0.90	
Thickness: 1.20mm					
5072-152	12.50	82.18	1.20	1.20	
5072-151	25.00	85.67	1.20	1.20	

## Stryker® Compatible Blades

Thickness: 1.24mm					
Cat. No.	Width (mm)	Length (mm)	Material Thickness (mm)	Cut Thickness (mm)	
5072-185	18.50	104.00	1.24	1.24	
Thickness: 1.27mm					
5072-110	24.82	73.79	1.27	1.27	
5072-111	24.82	80.14	1.27	1.27	
5072-158	12.50	82.20	1.27	1.27	
5072-101	19.50	86.00	1.27	1.27	
5072-181	19.50	86.00	1.27	1.27	

Stryker® Blade is a trademark of Stryker Corporation  
Grey shaded blades indicate coating.

Stryker® Blade is a trademark of Stryker Corporation  
Grey shaded blades indicate coating.

# Stryker® Replacement Blades

Indication for Use: Total Knee Arthroplasty



# Stryker® Replacement Blades

Indication for Use: Total Knee Arthroplasty

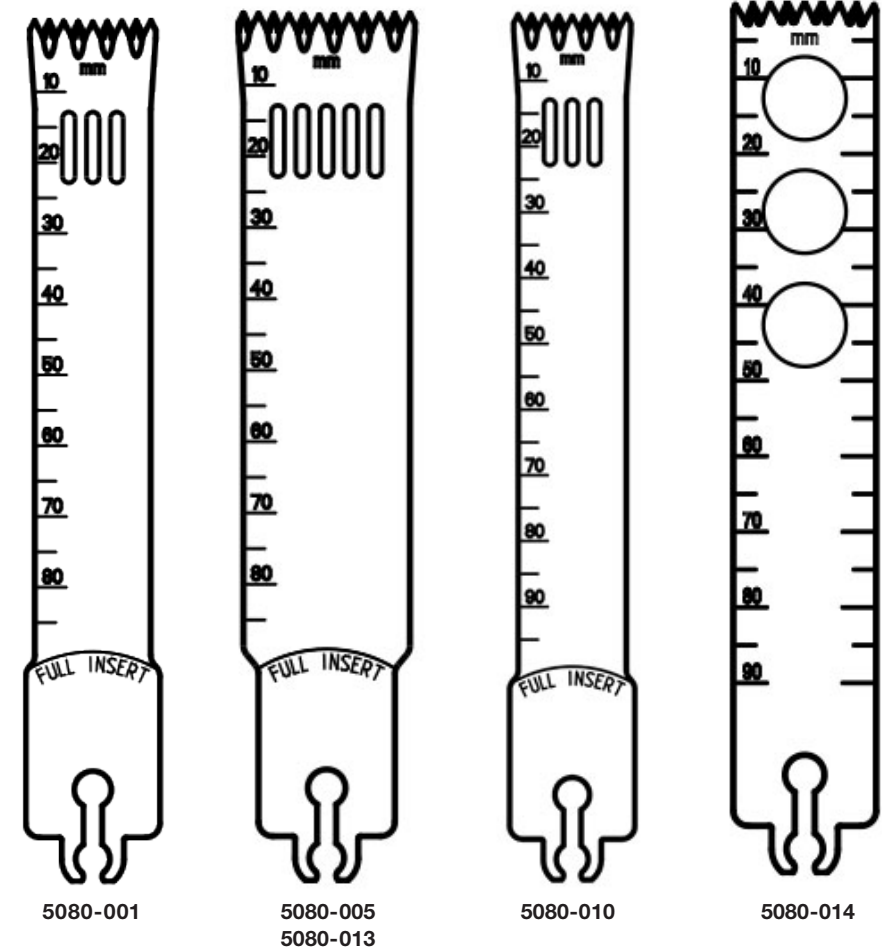
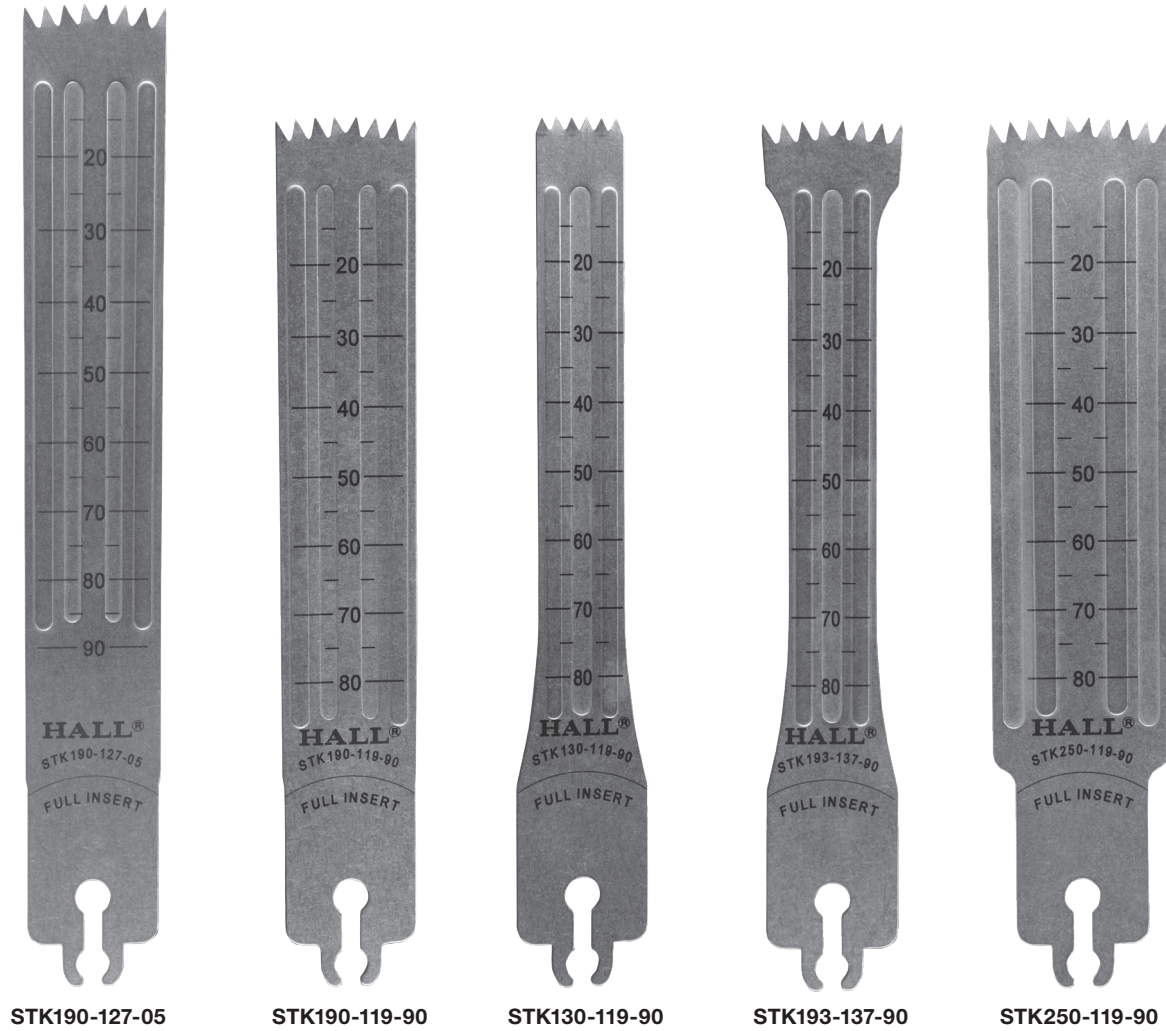

Blade images are 1:1 in length and width.





Body Width	19.0mm	19.0mm	13.0mm	19.0/13.0mm	25.0mm
Length	105.0mm	90.0mm	90.0mm	90.0mm	90.0mm
Thickness	Blade Catalog #				
0.89mm		STK190-089-90	STK130-089-90		STK193-137-90
1.00mm					STK250-100-90
1.07mm					
1.19mm		STK190-119-90	STK130-119-90		STK250-119-90
1.27mm	STK190-127-05	STK190-127-90	STK130-127-90		STK250-127-90
1.37mm		STK190-137-90		STK193-137-90	STK250-137-90
1.47mm					STK250-147-90

Blade images are 1:1 in length and width.

## Oscillating Large Bone

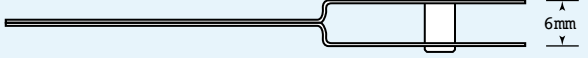
Body Width	18.0mm	25.0mm	18.0mm	19.0mm	25.4.0mm
Length	90.0mm	90.0mm	100.0mm	83.5mm	75.0mm
Thickness	Blade Catalog #				
1.27mm	5080-001	5080-005	5080-010		
1.19mm		5080-013			
1.25mm				5080-014	
0.89mm					5080-015

## Graft Harvesting Blades

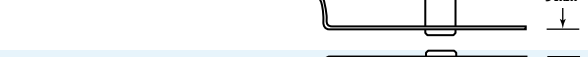
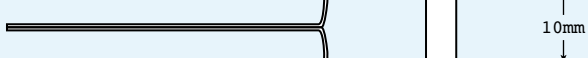
Graft Harvesting Blades					
Cat. No.	Depth Stop (mm)	Width (mm)	Material Thickness (mm)	Cut Thickness (mm)	
5071-106	20.00	16.50	0.40	6.00	
5071-107	20.00	16.50	0.40	7.00	
5071-108	20.00	16.50	0.40	8.00	
5071-109	20.00	16.50	0.40	9.00	
5071-110	20.00	16.50	0.40	10.00	
5071-111	20.00	16.50	0.40	11.00	

## ACL Blades

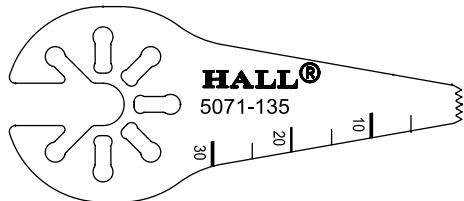
Thickness: 0.84mm					
Cat. No.	Width (mm)	Length (mm)	Material Thickness (mm)	Cut Thickness (mm)	
5071-571	9.50	30.00	0.64	0.84	
Thickness: 1.10mm					
5071-135	5.00	30.00	0.60	1.10	

## ACL Blades

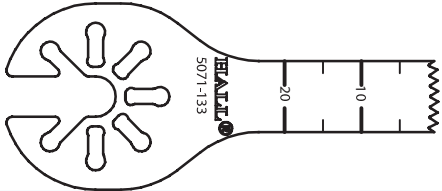
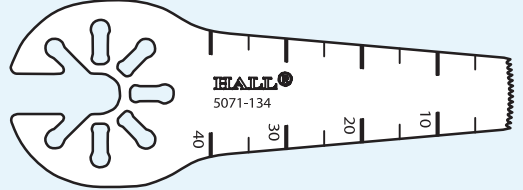
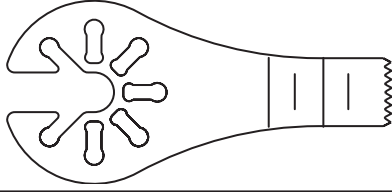
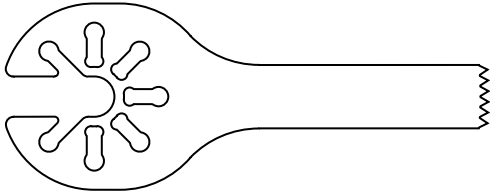
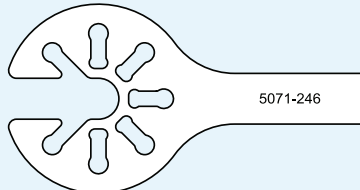
Thickness: 0.60mm					
Cat. No.	Width (mm)	Length (mm)	Material Thickness (mm)	Cut Thickness (mm)	
5071-133	9.50	25.50	0.40	0.60	
5071-134	9.00	41.00	0.40	0.60	
Thickness: 0.64mm					
5071-236	9.12	25.22	0.64	0.64	
Thickness: 0.80mm					
5071-127	8.50	38.00	0.40	0.80	
5071-246	5.50	25.50	0.60	0.80	

# Large Bone Oscillating Blades

Indications for Use: Total Hip Arthroplasty & Large Bone Trauma



# Large Bone Oscillating Blades

Indications for Use: Total Hip Arthroplasty & Large Bone Trauma

## Oscillating Blades

Thickness: 0.80mm					
Cat. No.	Width (mm)	Length (mm)	Material Thickness (mm)	Cut Thickness (mm)	
5071-132	19.50	41.00	0.40	0.80	
Thickness: 0.90mm					
5071-553	19.50	63.00	0.60	0.90	
5071-551	32.50	63.00	0.60	0.90	
5071-550	49.00	63.00	0.60	0.90	
5071-552	13.50	64.00	0.60	0.90	
5071-166	32.00	64.00	0.80	0.90	

Grey shaded blades indicate coating.

## Oscillating Blades

Thickness: 0.90mm					
Cat. No.	Width (mm)	Length (mm)	Material Thickness (mm)	Cut Thickness (mm)	
5071-186	32.00	64.00	0.80	0.90	
5071-556	33.50	64.00	0.80	0.90	
5071-177	19.50	71.00	0.80	0.90	
5071-187	19.50	71.00	0.80	0.90	
5071-572	19.50	71.00	0.80	0.90	
5071-178	19.50	80.00	0.80	0.90	
5071-188	19.50	80.00	0.80	0.90	

Grey shaded blades indicate coating.

All products may not be available in all markets.

All products may not be available in all markets.

# Large Bone Oscillating Blades

Indications for Use: Total Hip Arthroplasty & Large Bone Trauma



# Large Bone Oscillating Blades

Indications for Use: Total Hip Arthroplasty & Large Bone Trauma

## Oscillating Blades

Thickness: 0.90mm					
Cat. No.	Width (mm)	Length (mm)	Material Thickness (mm)	Cut Thickness (mm)	
5071-174	19.50	86.00	0.80	0.90	
5071-143	25.40	90.00	0.80	0.90	
Thickness: 1.06mm					
5071-557	12.50	73.80	0.63	1.06	
Thickness: 1.40mm					
5071-554	19.50	71.00	1.20	1.40	
5071-141	19.50	80.00	1.20	1.40	

## Oscillating Blades

Thickness: 1.40mm					
Cat. No.	Width (mm)	Length (mm)	Material Thickness (mm)	Cut Thickness (mm)	
5071-140	25.40	80.00	1.20	1.40	
5071-142	25.40	90.00	1.20	1.40	
Thickness: 1.50mm					
5071-555	33.00	71.00	1.20	1.50	
5071-145	13.00	72.00	1.20	1.50	

## Oscillating Abrader

Cat. No.	Width (mm)	Length (mm)	
5071-175	20.00	45.70	

# Large Bone Reciprocating Blades

Indications for Use: Total Hip Arthroplasty & Large Bone Trauma



# Large Bone Reciprocating Blades

Indications for Use: Total Hip Arthroplasty & Large Bone Trauma

## HALL® Reciprocating Blades

Thickness: 0.60mm					
Cat. No.	Width (mm)	Length (mm)	Material Thickness (mm)	Cut Thickness (mm)	
5052-260	12.50	38.00	0.40	0.60	
Thickness: 0.90mm					
5052-179	12.50	76.00	0.90	0.90	
Thickness: 1.00mm					
5052-259	9.40	54.50	0.60	1.00	
5052-173	12.50	73.50	0.80	1.00	
5052-258	12.50	89.00	0.60	1.00	
5080-020	12.00	82		1.00	
Thickness: 1.27mm					
5052-291	12.50	76.00	1.27	1.27	
Thickness: 1.50mm					
5052-276	13.00	48.00	1.50	1.50	
5052-281	9.40	54.50	1.50	1.50	
Thickness: 1.60mm					
5052-261	12.50	89.00	1.50	1.60	

## Stryker® Reciprocating Blades

Cat. No.	Width (mm)	Length (mm)	Material Thickness (mm)	Cut Thickness (mm)	
5052-334	12.50	73.50	0.60	0.60	
5052-332	12.00	76.00	0.80	0.80	
5052-135	12.50	76.00	0.90	0.90	
5052-333	12.00	76.00	1.30	1.30	
5080-003	12.50	70.00	0.60		
5080-004	12.50	70.00	0.08		
5080-012	11.20	77.50	0.08		
5080-017	12.50	70.00	1.00		



PRO8000SB

PRO8100SB



PRO8200SB

PRO8300SB



PRO8400SB

### HALL® MicroFree® Handpieces

	Cat. No.
HALL® MicroFree® High Speed Drill.....	PR08000SB
HALL® MicroFree® Medium Speed Drill.....	PR08100SB
HALL® MicroFree® Sagittal Saw.....	PR08200SB
HALL® MicroFree® Oscillating Saw.....	PR08300SB
HALL® MicroFree® Reciprocating Saw.....	PR08400SB

### HALL® MicroFree® Lithium Power Unit

	Cat No.
HALL® MicroFree® Lithium Power Unit.....	L3500SB

### HALL® MicroFree® Adapter and Charger

HALL® Large Lithium Battery.....	L3000LG
HALL® Small Lithium Battery.....	L3000SM
HALL® MicroFree® Power Unit Adapter.....	L3500
HALL® Lithium Charger.....	L3000

### HALL® MicroFree® Mini-Driver

HALL® MicroFree® Mini-Driver.....	PR08500SB
-----------------------------------	-----------



L3500SB



L3000SM

L3000LG



L3500



L3000



PRO8500SB



**PRO7000DE**



**PRO7000SE**



**PRO7100SE**



**PRO7200SE**

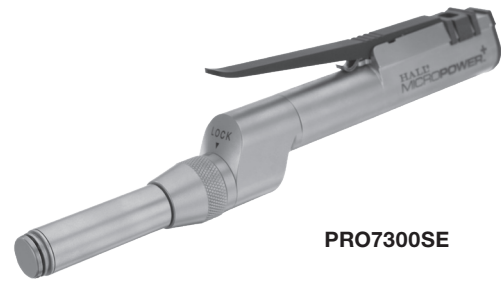

**PRO7300SE**

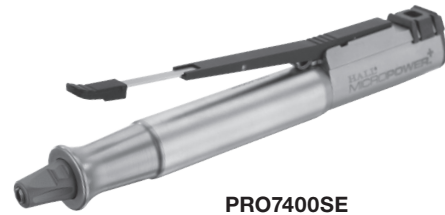

**PRO7400SE**

Attachments on page 49

Handpieces	
	Removable Lever
Oral Max Elite High Speed Drill	PRO7000DE
Orthopedic High Speed Drill	PRO7000SE
Medium Speed Drill	PRO7100SE
Sagittal Saw	PRO7200SE
Oscillating Saw	PRO7300SE
Reciprocating Saw	PRO7400SE

**Handpieces**

	Cat. No.
Surgairtome Two® High Speed Drill Kit (System listing on page 83) .....	5058-000
Surgairtome Two High Speed Drill .....	5058-001
Medium Speed Drill .....	5053-009
Reciprocating Saw .....	5053-010
Sagittal Saw .....	5053-011
Oscillating Saw .....	5053-012
Wire Driver .....	5053-013
Throttle Clip (for lever) Used during footswitch operation .....	5053-074



**5058-001**



**5053-009**



**5053-010**



**5053-011**



**5053-012**



**5053-022**



**5053-013**

**5053-074**

**Attachments & Accessories**

Wire Guard for use with 5053-013 .....	5053-123
Wire Driver Adapter Chuck for use with 5053-013 .....	5053-019
Replacement Hex Wrench for Micro 100™ Sagittal & Oscillating Saw .....	1365-005
Burguard Sleeve Surgairtome Two .....	1375-112
Smartguard Irrigator .....	6020-260

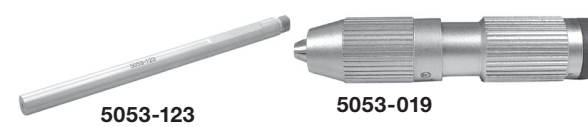

**5053-123**

**5053-019**

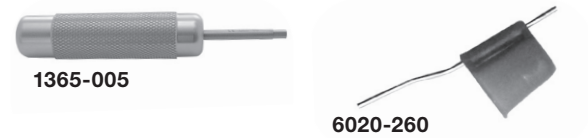

**1365-005**

**6020-260**

Attachments on Page 49



# Attachments & Bur Guards

For Use with Micro Handpieces



# Sterilization Trays

For Use with Micro Handpieces

## Attachments

Cat. No.

Medium Precision Bur Guard..... 1375-012P

Long Precision Bur Guard ..... 1375-011P

X-Long Precision Bur Guard ..... 1375-023P

Medium Bur Guard ..... 1375-012

Long Bur Guard..... 1375-011

X-Long Bur Guard..... 1375-023

Irrigation Tubing Set..... E9418

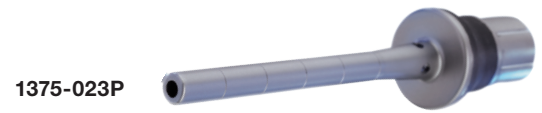
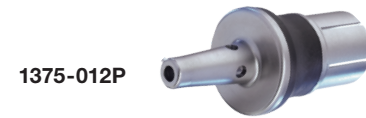

## HALL® Sterilization Containers/Inner Trays

Cat. No.

½ Size Rigid Sterilization Container ..... TR12R

### Sterilization Inner Trays

½ Size Inner Tray, Small Bone Set..... PRO7003T

½ Size Inner Tray, Drill Set..... PRO8003T

½ Size Inner Tray, Drill Set with Mini Driver ..... PRO8001T

Small Bone Tray ..... PRO6000



PRO7003T

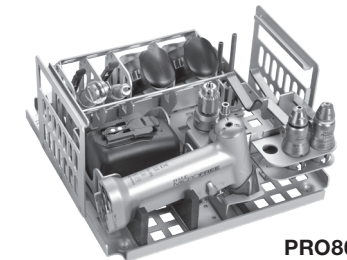

PRO8001T



TR12R with PRO8003T

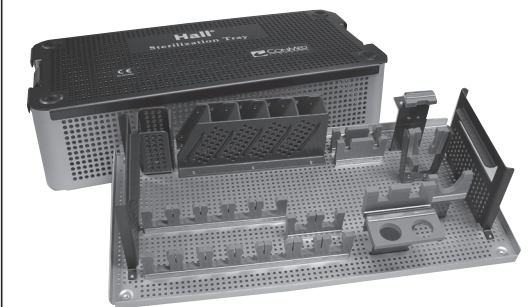

PRO6000

## Sagittal Saw Blades

Thickness: 0.60mm						
Cat. No.	Tooth	Width (mm)	Length (mm)	Material Thickness (mm)	Cut Thickness (mm)	
5023-144	Fine	5.50	18.50	0.40	0.60	
5023-118	Fine	9.50	25.50	0.40	0.60	
5023-130	Coarse	19.50	25.50	0.40	0.60	
5023-131	Coarse	19.50	41.00	0.40	0.60	
5023-132	Coarse	5.50	25.50	0.40	0.60	
5023-133	Coarse	14.00	41.00	0.40	0.60	
5023-137	Coarse	14.00	25.50	0.40	0.60	
5023-138	Fine	9.50	25.50	0.40	0.60	
5023-139	Fine	4.50	25.50	0.40	0.60	
5023-140	Tapered/Fine	9.50	41.00	0.40	0.60	

## Sagittal Saw Blades

Thickness: 0.60mm						
Cat. No.	Tooth	Width (mm)	Length (mm)	Material Thickness (mm)	Cut Thickness (mm)	
5023-141	Fine	6.00	34.00	0.40	0.60	
5023-142	Fine	4.00	34.00	0.40	0.60	
5023-143	Coarse	9.50	25.50	0.40	0.60	
5023-244	Fine	4.00	6.00	0.40	0.60	
5023-245	Fine	5.50	25.5	.06		
5044-145	Fine	10.00	18.50	0.40	0.60	
5023-247	Fine	9.50	25.50	0.60	0.60	
5023-249	Fine	9.00	31.00	0.40	0.60	
5080-024		7.0	18.5	0.40		
5080-025		13.0	39.0	0.50		

All products may not be available in all markets.

All products may not be available in all markets.

## Stryker® Hub Capatible Sagittal Saw Blades

Thickness: 0.60mm					
Cat. No.	Tooth	Width (mm)	Length (mm)	Material Thickness (mm)	
5080-002	Fine	9.80	25.0	0.40	
5080-008	Fine	5.50	18.0	0.40	
5080-009	Fine	9.80	18.0	0.40	
5080-011	Fine	9.50	25.0	0.50	
5080-016	Fine	9.50	31.0	0.40	
5080-020	Fine	12.0	82.0	1.00	
5080-022	Fine	32.0	19.0	0.40	
5080-023	Fine	32.8	0.60		
5080-024	Fine	18.5	7.00	.040	
5080-025	Fine	39.0	13.0	0.50	

Stryker® Blade is a trademark of Stryker Corporation

## Angled Sagittal Saw Blades

Thickness: 0.60mm							
Cat. No.	Tooth	Angle	Width (mm)	Length (mm)	Material Thickness (mm)	Cut Thickness (mm)	
5023-128	Fine	70 Degree	9.50	7.50	0.40	0.60	
5023-129	Fine	70 Degree	9.50	13.50	0.40	0.60	
5023-134	Coarse	90 Degree	5.50	9.00	0.40	0.60	
5023-135	Coarse	45 Degree	5.50	18.00	0.40	0.60	
5023-136	Coarse	90 Degree	14.00	15.50	0.40	0.60	

All products may not be available in all markets.

## ACL Blades

Thickness: 0.60mm								
Cat. No.	Tooth	Edge	Depth Stop (mm)	Width (mm)	Length (mm)	Material Thickness (mm)	Cut Thickness (mm)	
C8803	Fine	Straight	8.0 with guide/ 12 without guide	9.40	41.00	0.38	0.60	
C8804	Fine	Straight	8.0 Freehand	9.40	41.00	0.38	0.60	
C8806	Fine	Straight	10.0 Freehand	9.40	41.00	0.38	0.60	
8703	Fine	Straight	8.0 with guide/ 12 without guide	9.50	25.50	0.40	0.60	
5023-183	Fine	Straight	None	9.50	25.50	0.40	0.60	
5023-184	Tapered/Fine	Straight	None	9.50	41.00	0.40	0.60	
5023-185	Tapered/Coarse	Straight	None	6.50	30.00	0.40	0.60	
Thickness: 0.69mm								
5023-182	Coarse	Straight	None	19.00	41.00	0.40	0.69	
Thickness: 0.74mm								
5023-186	Coarse	Straight	None	8.50	38.00	0.40	0.74	

## Dermabraders

Thickness: 3.80mm						
Cat. No.	Tooth	Edge	Width (mm)	Length (mm)	Material Thickness (mm)	
5023-055	Abrader	Straight	25.00	6.30	3.80	
5023-056	Abrader	25 Degree	25.00	6.30	3.80	

## Graft Harvesting Blades

Cat. No.	Depth Stop (mm)	Width (mm)	Material Thickness (mm)	Cut Thickness (mm)	
5023-405	20.00	16.50	0.40	5.00	
5023-406	20.00	16.50	0.40	6.00	
5023-407	20.00	16.50	0.40	7.00	
5023-408	20.00	16.50	0.40	8.00	
5023-409	20.00	16.50	0.40	9.00	
5023-411	20.00	16.50	0.40	11.00	
5023-412	20.00	16.50	0.40	12.00	

## Oscillating Saw Blades

Thickness: 0.60mm							
Cat. No.	Tooth	Edge	Width (mm)	Length (mm)	Material Thickness (mm)	Cut Thickness (mm)	
5023-160	Fine	Straight	5.50	12.00	0.40	0.60	
5023-161	Fine	Straight	10.00	12.00	0.40	0.60	
5023-162	Fine	Straight	5.50	18.50	0.40	0.60	
5023-163	Fine	Straight	10.00	18.50	0.40	0.60	
5023-164	Fine	Straight	5.50	28.50	0.40	0.60	
5023-165	Fine	Radial	10.00	28.50	0.40	0.60	
5023-166	Fine	Radial	18.50	28.50	0.40	0.60	
5023-169	Fine	Straight	10.00	35.00	0.40	0.60	
5080-022			19.50	32.00	0.40		

## Angled Oscillating Saw Blades

Thickness: 0.60mm							
Cat. No.	Tooth	Edge	Width (mm)	Length (mm)	Material Thickness (mm)	Cut Thickness (mm)	
5023-258	Fine	Radial/20 Degree	10.00	9.00	0.40	0.60	
5023-259	Fine	Radial/20 Degree	10.00	13.50	0.40	0.60	
5023-167	Fine	20 Degree	5.50	13.00	0.40	0.60	
5023-168	Fine	Radial/20 Degree	10.00	13.00	0.40	0.60	

## Intra-Oral Blades \*Not for use with Micro 100™

Thickness: 0.60mm							
Cat. No.	Tooth	Width (mm)	Length (mm)	Material Thickness (mm)	Cut Thickness (mm)	Cutting Depth (mm)	
5023-101*	Coarse	11.50	7.00	0.40	0.60	7.00	
5023-102*	Coarse	11.50	12.00	0.40	0.60	12.00	
5023-103*	Coarse	9.00	12.00	0.40	0.60	12.0	
5023-104*	Coarse	5.00	12.00	0.40	0.60	12.00	

All products may not be available in all markets.

All products may not be available in all markets.

## Crescentic Blades

Thickness: 0.60mm							
Cat. No.	Tooth	Width (mm)	Length (mm)	Material Thickness (mm)	Cut Thickness (mm)	Cutting Depth (mm)	
5023-170	Fine	9.0	12.00	0.40	0.60	12.00	
5023-171	Fine	13.5	25.50	0.40	0.60	25.50	
5023-172	Fine	18.0	32.00	0.40	0.60	32.00	
5023-176	Fine	13.5	32.00	0.40	0.60	32.00	

## Reciprocating Rasp

Cat. No.	Shank	Width (mm)	Length (mm)	
5053-080	Round	5.50	9.50	
5053-082	Round	5.50	9.50	
5053-081	Round	6.50	12.50	
5053-083	Round	6.50	12.50	
5053-084	Round	5.30	24.50	
5053-085	Round	9.50	30.50	
5080-007**	Round	5.50	73.00	











\*\*Stryker Rasp Replacement







## Reciprocating Saw Blades



Cat. No.	Shank	Length (mm)	Material Thickness (mm)	
5053-122	Flat	25.50	0.25	
5053-220	Flat	25.50	0.40	
5053-221	Flat	38.00	0.40	
5053-054	Round	25.00	0.60	
5053-126	Round	28.00	0.60	





## Depth Limiting Reciprocating Saw Blades





Thickness: 4.00mm					
Cat. No.	Shank	Length (mm)	Material Thickness (mm)	Cut Depth (mm)	
5053-051	Round	17.00	0.60	4.00	
Thickness: 5.00mm					
5053-050	Round	7.00	0.60	5.00	
5053-052	Round	23.00	0.60	5.00	
Thickness: 7.00mm					
5053-053	Round	25.00	0.60	7.00	

	Round Fluted											
	Flutes (mm)	6.00	6.00	8.00	6.00	8.00	6.00	8.00	8.00	10.00	10.00	10.00
MicroPower & Micro 100 Bur Guards	Diameter (mm)	1.00	1.50	1.80	2.00	2.30	2.40	3.00	4.00	5.00	6.00	6.50
1375-012			5091-222	5091-221	5091-224	5091-223	5091-225	5091-226	5091-228	5091-230	M60R	5091-232
1375-011		5092-220	5092-222	L18R	5092-224	L23R		5092-226	5092-228	5092-230	L60R	5092-232
1375-023		5093-220			5093-224			5093-226	5093-228	5093-230	X60R	5093-232













	Fine Round Diamond						
	Diameter (mm)	1.00	2.00	3.00	4.00	5.00	6.00
1375-012				5091-260		5091-264	5091-268
1375-011			L10D	5092-260	5092-262	5092-264	5092-266
1375-023			X10D	5093-260	5093-262	5093-264	5093-266





	Wire Pass Burs			
	Flutes (mm)	2.00	2.00	2.00
MicroPower & Micro 100 Bur Guards	Diameter (mm)	1.00	1.50	2.00
Length (mm)	19.00	19.00	19.00	
		5090-247	5090-248	5090-249
		5090-247	5090-248	5090-249
1375-011		5092-247		
		5092-247		
1375-012		5091-247	5091-248	5091-249





	Swanson Reamers				
	Flutes (mm)	4.00	6.00	6.00	8.00
MicroPower & Micro 100 Bur Guards	Diameter (mm)	2.00	3.00	4.00	5.00
1375-012		5091-242	5091-243	5091-244	5091-245



	Dermabraders - Fine Diamond					N/A	N/A	N/A	N/A	
	Diameter (mm)	2.00	4.00	6.00	4.00	4.00	7.00	12.00	10.00	2.00
MicroPower & Micro 100 Bur Guards	Bur Head Length (mm)				8.00	15.00	15.00	15.00	15.00	19.00
1375-012		5091-260	5091-264	5091-268	5091-270		5091-081	5091-082	5091-083	
1375-011					5092-270					





Bur Shank Diameter 2.34mm (0.82")

	Straight Side Cutting Burs												
	Flutes (mm)	6.00	6.00	6.00	6.00	6.00	6.00	6.00	6.00	6.00	6.00	6.00	6.00
MicroPower & Micro 100 Bur Guards	Diameter (mm)	1.00	1.10	1.20	1.30	1.30	1.50	1.50	1.50	1.60	1.60	1.70	1.70
Bur Head Length (mm)	5.00	5.00	4.90	9.90	9.90	5.10	8.00	10.00	4.30	7.50	12.00	9.90	9.90
1375-012		5091-201	M10S	5091-216		M13S	5091-204		5091-202	5091-217	M15S		M17S
1375-011					L13S		5092-204					5092-203	L17S

	Tapered Side-cutting						
	Diameter (mm)	0.80	1.20	1.20	1.20	1.60	1.60
MicroPower & Micro 100 Bur Guards	Bur Head Length (mm)	4.90	9.90	3.70	9.90	21.60	4.30
1375-012		5091-215	M12T	5091-219		M20T	5091-218
1375-011					L12T		

	Tapered Side-cutting					
	Diameter (mm)	1.60	2.00	2.00	2.00	2.00
MicroPower & Micro 100 Bur Guards	Bur Head Length (mm)	21.90	7.50	19.00	7.50	19.00
1375-012			5091-206	5091-214		
1375-011			L20T		5092-206	5092-214

	Barrel Burs		
	Flutes (mm)	6.00	6.00
MicroPower & Micro 100 Bur Guards	Diameter (mm)	2.00	4.00
Bur Head Length (mm)	10.00	10.00	
1375-012		5091-252	5091-254
1375-011		5092-252	5092-254

	Oval Burs				
	Flutes (mm)	8.00	8.00	8.00	8.00
MicroPower & Micro 100 Bur Guards	Diameter (mm)	4.00	5.50	4.00	5.50
Bur Head Length (mm)	8.00	10.0	7.9	10.0	
1375-012		5091-236	5091-238	M40B	M55B
1375-011		5092-236	5092-238	L40B	L55B
1375-023			5093-238	X40B	



# Micro Burs





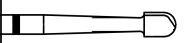



# Sternum Saws

	<b>Lindemann Burs</b>	
	Flutes (mm)	4.00
	Diameter (mm)	1.60
<b>MicroPower &amp; Micro 100 Bur Guards</b>	Bur Head Length (mm)	31.00
1375-012		5091-212

	<b>Cylindrical</b>	
	Flutes (mm)	2.00
	Diameter (mm)	3.00
<b>MicroPower &amp; Micro 100 Bur Guards</b>	Bur Head Length (mm)	4.00
1375-011		5092-291

	<b>Cone Burs</b>		
	Flutes (mm)	8.00	12.00
	Diameter (mm)	4.50	4.50
<b>MicroPower &amp; Micro 100 Bur Guards</b>	Bur Head Length (mm)	12.00	12.00
1375-012		M45C	
1375-011			L45C

	<b>Tapered Cross-cut Fissure Burs</b>			
	Flutes (mm)	701 Type	702 Type	703 Type
	Diameter (mm)	1.20	1.60	2.10
<b>MicroPower &amp; Micro 100 Bur Guards</b>	Bur Head Length (mm)	2.30	3.80	4.90
1375-012		5091-271	5091-272	5091-213
1375-011		5092-271	5092-272	5092-273

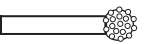
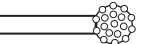
	<b>Heavy Grit Diamond-Microbur. X-Long</b>					
<b>MicroPower &amp; Micro 100 bur guards</b>	Diameter (mm)	2.00	3.00	4.00	5.00	6.00
	Grit	60-70	60-70	40-45	40-45	40-45
1375-023		5093-282	5093-283	5093-284	5093-285	
1375-011			5092-283	5092-284	5092-285	

**Cat. No.**  
 HALL® 50™ Sternum Saw Handpiece ..... PRO7450B  
 MPower® 2 Battery Sternum Saw ..... PRO6450M  
 See pages 8, and 9 for battery accessories.  
 Saw does not include sternum guard or blade.



Pneumatic Sternum Saw ..... 5059-005



Sternum Saw Wrench, for PRO7450B, PRO6450, PRO6450M & 5059-005 ..... 5059-007



Sternum Guard, 2.25" (5.72mm), for PRO7450B, PRO6450, PRO6450M & 5059-005 ..... 5059-006



Sternum Guard, 3.12" (7.92mm), for PRO7450B, PRO6450, PRO6450M & 5059-005 ..... 5059-011



Repeat Sternotomy Saw, Pneumatic ..... 5057-040

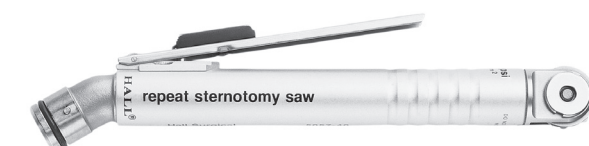



# Sternum Saw Blades

Indications for Use: Primary & Repeat Sternotomy



# Sternum Saw Blades

Indications for Use: Primary & Repeat Sternotomy

## Sternum Saw Blades

\*\* For use with Stryker® Sternum Saw

Cat. No.	Width (mm)	Length (mm)	Non-sterile	
5059-235**		32.00		
5080-006**	0.80	31.00		
5059-532	10.00	35.00		
5059-032-01	10.00	35.00	50 Pack	
5059-531	10.00	54.00		
5059-031	10.00	54.00		
5059-031-01	10.00	54.00	50 Pack	
5080-023	32.8	60.00		

## Repeat Sternotomy Blades

Cat. No.	Width (mm)	Length (mm)		Cat. No.	Width (mm)	Length (mm)	
1384-175	52.00	19.00		5023-187	50.00	24.00	
1384-176	63.00	19.00		5023-188	63.00	24.00	

## Repeat Sternotomy Blades

Cat. No.	Width (mm)	Length (mm)		Cat. No.	Width (mm)	Length (mm)	
5023-178	44.60	40.00		5059-278	44.60	40.00	
5023-179	54.60	40.00		5059-279	54.60	40.00	
5023-180	65.80	40.00		5059-280	65.80	40.00	

All products may not be available in all markets.

# Sternum Saw Blades

Indications for Use: Primary & Repeat Sternotomy



# Ultrapower®

Indications for Use: Spine & Neuro

## Repeat Sternotomy Blades

Cat. No.	Width (mm)	Length (mm)
5071-125	50.00	19.00
5071-126	63.00	19.00
5071-228	44.50	40.00

Cat. No.	Width (mm)	Length (mm)
5071-229	54.50	40.00
5071-230	66.00	40.00



7020-001



7020-003



7020-045

## Handpieces

	Cat. No.
Ultrapower High Speed Drill .....	7020-001
Ultrapower Perforator Drive.....	7020-003

## Attachments & Accessories

Ultrapower Footswitch .....	7020-045
Short Bur Guard (like Midas-X) Red.....	7020-010
Medium Bur Guard (like Midas-O) Copper .....	7020-011
Long Bur Guard (like Midas-M/B) Mustard .....	7020-012
X-Long Bur Guard (like Midas-AM/A) Lime .....	7020-013
Short Revision Extension (like Midas TU) Teal .....	7020-014
Medium Revision Extension (like Midas-R) Purple .....	7020-015
Short Bur Guard (like Midas B-5) Black.....	7020-017
Medium Bur Guard (like Midas B-1) Green.....	7020-018
Long Bur Guard (like Midas S-1) Brown .....	7020-019

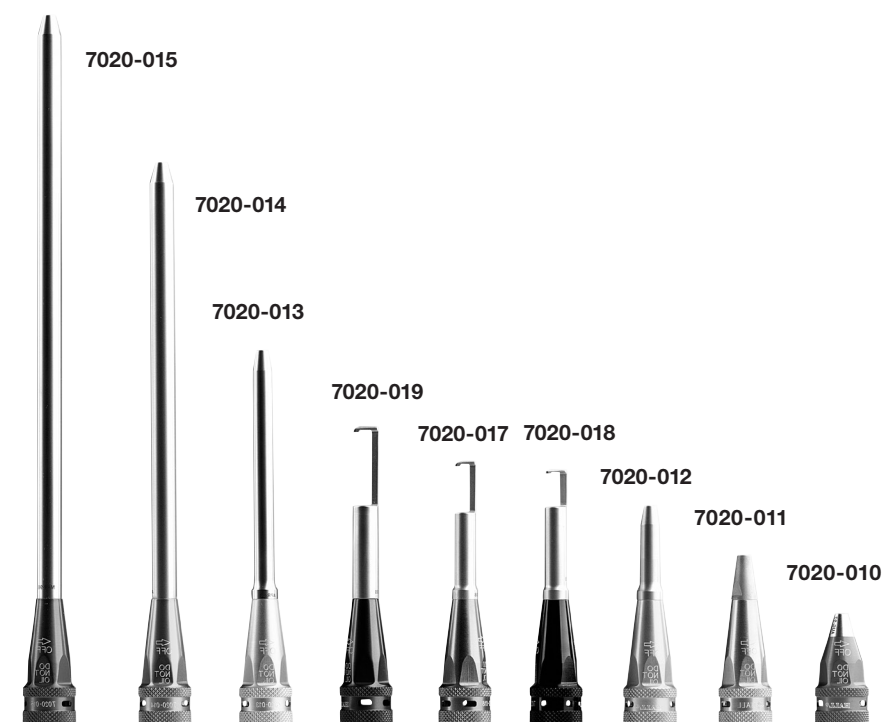

# UltraPower® Burs

Indications for Use: Otology  
(Round Burs Only), Spine & Neuro



# UltraPower® Burs

Indications for Use: Otology  
(Round Burs Only), Spine & Neuro

	Round Fluted									
	Flutes (mm)	4.00	6.00	6.00	6.00	8.00	8.00	8.00	8.00	8.00
UltraPower Bur Guard No.	Diameter (mm)	0.50	1.00	1.50	2.00	2.50	3.00	4.00	5.00	6.00
7020-010								7021-027	7021-028	7021-029
7020-011				7021-123	7021-124	7021-125	7021-126	7021-127	7021-128	7021-129
7020-012		7021-220	7021-222	7021-223	7021-224	7021-225	7021-226	7021-227	7021-228	7021-229
7020-013			7021-322	7021-323	7021-324	7021-325	7021-326	7021-327	7021-328	7021-329
7020-014							7021-426		7021-428	7021-429
7020-015									7021-528	7021-529

	Coarse Round Diamond						
UltraPower Bur Guard No.	Diameter (mm)	2.00	3.00	4.00	5.00	6.00	7.00
7020-010				7021-074	7021-075		7021-077
7020-011		7021-172	7021-173	7021-174	7021-175	7021-176	7021-177
7020-012		7021-272	7021-273	7021-274	7021-275	7021-276	7021-277
7020-013		7021-372	7021-373	7021-374	7021-375	7021-376	
7020-014				7021-474			

	Round Fluted					
	Flutes (mm)	10	10	10	10	10
UltraPower Bur Guard No.	Diameter (mm)	6.5	7.5	8.0	9.0	10.0
7020-010		7021-030				
7020-011		7021-130	7021-131	7021-134	7021-132	7021-133
7020-012		7021-230	7021-231		7021-232	7021-233
7020-013			7021-331		7021-332	7021-333
7020-014			7021-431		7021-432	
7020-015			7021-531		7021-532	7021-533

	Side Cutting, Burs						
	Flutes (mm)	8.00	8.00	8.00	8.00	8.00	12.00
	Diameter (mm)	5.00	7.50	7.50	9.00	9.00	10.50
UltraPower Bur Guard No.	Bur Head Length (mm)	17.00	5.00	9.00	5.00	9.00	11.00
7020-013		7021-303	7021-305				11.00
7020-014					7021-408		
7020-015						7021-509	

	Fine Round Diamond							
UltraPower Bur Guard No.	Diameter (mm)	1.0	2.0	3.0	4.0	5.0	6.0	7.0
7020-010			7021-062	7021-063	7021-064			
7020-011			7021-162	7021-163	7021-164	7021-165	7021-166	7021-167
7020-012		7021-261	7021-262	7021-263	7021-264	7021-265	7021-266	7021-267
7020-013		7021-361	7021-362	7021-363	7021-364	7021-365	7021-366	7021-367





# UltraPower® Burs

Indications for Use: Otolaryngology  
(Round Burs Only), Spine & Neuro





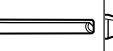
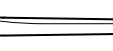

# UltraPower® Burs

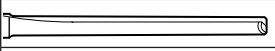
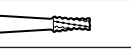

Indications for Use: Otolaryngology  
(Round Burs Only), Spine & Neuro

UltraPower Bur Guard No.	Side Cutting Burs							
		Flutes (mm)	1.00	1.00	1.00	2.00	2.00	2.00
	Diameter (mm)	1.50	1.8	2.00	1.20	2.20	2.20	3.00
UltraPower Bur Guard No.	Bur Head Length (mm)	8.00	11.00	16.0	6.00	16.00	23.00	25.00
7020-010			7021-013			7021-015		
7020-011		7021-112	7021-113				7021-116	
7020-012			7021-713	7021-214	7021-243	7021-815		7021-917
7020-013				7021-314		7021-315		

UltraPower Bur Guard No.	Side Cutting Burs		
		Flutes (mm)	2.00
	Diameter (mm)	3.00	1.50
UltraPower Bur Guard No.	Bur Head Length (mm)	36.00	4.90
7020-011			7021-119
7020-012		7021-218	
7020-013		7021-318	

UltraPower Bur Guard No.	Fluted Cylindrical Burs			
		Flutes (mm)	2.00	2.00
	Diameter (mm)	1.80	2.20	3.00
7020-010				
7020-011			7021-136	7021-137
7020-012			7021-236	7021-237
7020-013		7021-335	7021-336	7021-337
7020-014				7021-437

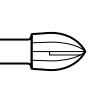
UltraPower Bur Guard No.	Fine Diamond Cylindrical Burs		
		Diameter (mm)	1.90
7020-012			7021-279
7020-013		7021-378	7021-379

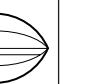
UltraPower Bur Guard No.	Fluted Acorn Burs				
		Flutes (mm)	8.00	8.00	8.00
	Diameter (mm)	5.00	6.00	7.50	9.00
7020-012		7021-280	7021-281	7021-282	7021-283
7020-013		7021-380	7021-381	7021-382	7021-383
7020-015			7021-581		7021-583

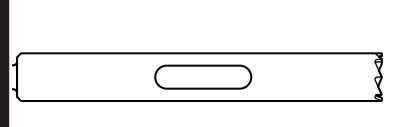
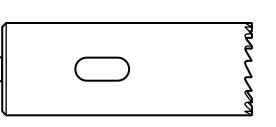
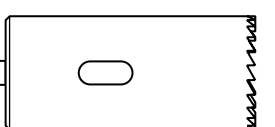
UltraPower Bur Guard No.	Trephine Burs			
		Diameter (mm)	5.30	10.70
7020-010		7021-051		
7020-012			7021-252	7021-253

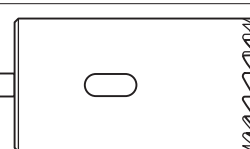
UltraPower Bur Guard No.	Trephine Burs	
		Diameter (mm)
7020-012		7021-255

# UltraPower® Burs

Indications for Use: Otolaryngology  
(Round Burs Only), Spine & Neuro





# E9005 ENT Shaver Blades

Indications for Use: Sinus Surgery

	Wire Pass Burs 
	Flutes (mm) 2.00
UltraPower Bur Guard No.	Diameter (mm)
7020-010	7021-042
7020-011	7021-142

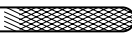
	Oval Fluted Burs 
	Flutes (mm) 8.00 8.00
	Diameter (mm) 4.00 5.50
UltraPower Bur Guard No.	Bur Head Length (mm)
7020-010	7021-095
7020-011	7021-195 7021-196
7020-012	7021-295 7021-296
7020-013	7021-395 7021-396

	Carbide Metal Cutting Burs 
	Diameter (mm) 3.20
UltraPower Bur Guard No.	Bur Head Length (mm)
7020-010	7021-094
7020-012	7021-294

	Carbide Metal Cutting Burs 
	Flutes (mm) 8.00
	Diameter (mm) 6.00
UltraPower Bur Guard No.	Bur Head Length (mm)
7020-012	7021-297

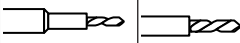
	Wire Pass Burs – Depth Limiting 
	Diameter (mm) 1.10 1.50
UltraPower Bur Guard No.	Depth (mm)
7020-011	7021-141-50 7021-145-70

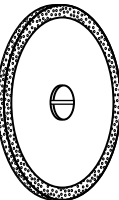
	Fine Diamond Wheels for Metal Cutting 
UltraPower Bur Guard No.	Diameter (mm)
7020-010	7021-092
7020-012	7021-292
7020-013	7021-392
7020-014	7021-492

**For use with:**  
E9005 High Speed Shaver

### MicroXcisor® Blade

4.2mm, Irrigated, 10.5cm Working Length, 6/Box ..... N9330

Cat. No.



Ideal for aggressive removal of ethmoid bone, cartilage and soft tissue

### Lynx® Blade

4.2mm, Irrigated, 10.5cm Working Length, 6/Box ..... N9150



Ideal for aggressive removal of ethmoid bone, cartilage and soft tissue

### Rhinotec® Cuda® Blade

- 4.2mm, Bendable to 30°, Irrigated, 10.5cm Working Length, 6/Box ..... E9350
- 3.7mm, Bendable to 30°, Irrigated, 10.5cm Working Length, 6/Box ..... E9351
- 4.2mm, Bendable to 45°, 10.5cm Working Length, 6/Box ..... A9350
- 4.2mm, Irrigated, 10.5cm Working Length, 6/Box ..... N9210
- 3.5mm, 7.6cm Working Length, 6/Box ..... C9952
- 2.9mm, 7.6cm Working Length, 6/Box ..... C9951
- 2.0mm, 7.6cm Working Length, 6/Box ..... C9950



Ideal for removal of soft tissue  
Products not shown at actual size.

# E9000<sup>®</sup> System

Indications for Use: ENT, Spine & Neuro



# E9005 ENT Shaver Blades

Indications for Use: Sinus Surgery

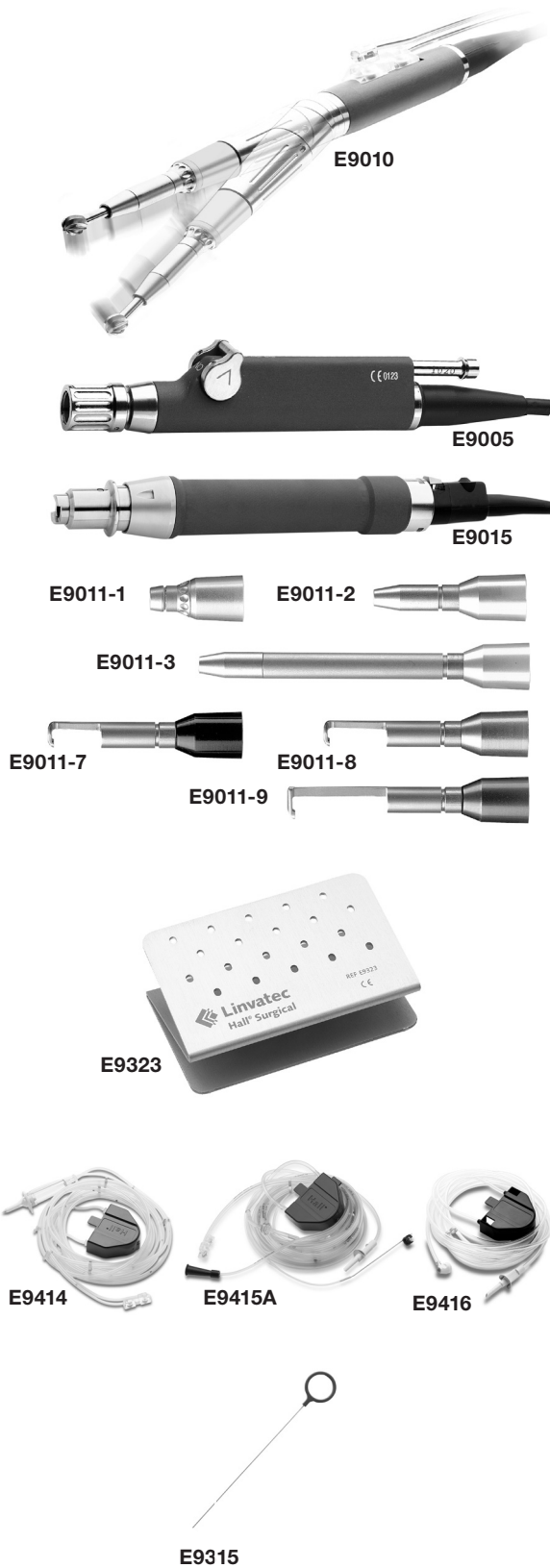

## Handpieces

	Cat. No.
CoolFlex <sup>®</sup> High Speed Drill .....	E9010

High Speed Shaver .....	E9005
-------------------------	-------

Cranial Perforator Drive.....	E9015
-------------------------------	-------

## Attachments & Accessories

Medium Bur Guard for E9010 Drill .....	E9011-1
--	---------

Long Bur Guard for E9010 Drill .....	E9011-2
--------------------------------------	---------

X-Long Bur Guard for E9010 Drill.....	E9011-3
---------------------------------------	---------

Short Neuro Guard for E9010 Drill.....	E9011-7
--	---------

Medium Neuro Guard for E9010 Drill.....	E9011-8
---	---------

Long Neuro Guard for E9010 Drill .....	E9011-9
--	---------

Bur Rack, Holds up to 20 burs for E9010 Drill .....	E9323
---	-------

Drill Tubing for E9010 Drill without irrigation tip .....	E9414
---	-------

Drill Tubing for E9010 Drill with irrigation tip.....	E9415A
---	--------

4.2mm FESS Irrigation Tubing Set for E9005 Shaver .....	E9416
---	-------

3.7mm FESS Irrigation Tubing Set for E9005 Shaver (Not Shown).....	E9417
--	-------

DeClogger for removing tissue and bone from shaver blades and burs .....	E9315
--	-------

## Rhinotec<sup>®</sup> Gator<sup>®</sup> Blade

	Cat. No.
4.2mm, Bendable to 30°, Irrigated, 10.5cm Working Length, 6/Box.....	E9360

3.7mm, Bendable to 30°, Irrigated, 10.5cm Working Length, 6/Box.....	E9361
--	-------

4.2mm, Bendable to 45°, 10.5cm Working Length, 6/Box .....	A9360
--	-------

4.2mm, Irrigated, 10.5cm Working Length, 6/Box .....	N9220
--	-------

3.5mm, 7.6cm Working Length, 6/Box.....	C9962
---	-------

2.9mm, 7.6cm Working Length, 6/Box.....	C9961
---	-------

2.0mm, 7.6cm Working Length, 6/Box.....	C9960
---	-------

## Head & Neck Blade

4.2mm, 11.5cm Working Length, 6/Box.....	N9321
--	-------

## Laryngeal Blade

3.7mm, Bendable to 45°, 20.0cm Working Length, 6/Box .....	E9363
--	-------



Ideal for aggressive removal of soft tissue, cartilage and thin bone



Ideal for the most gentle removal of soft tissue



Ideal for removal of soft tissue in laryngeal procedures

# E9005 ENT Shaver Blades

Indications for Use: Sinus Surgery



# E9005 ENT Shaver Blades

Indications for Use: Sinus Surgery



Ideal for aggressive removal of hard bone and cartilage

## Rhinotec® Vortex® Router

	Cat. No.
3.5mm, Hooded, 7.6cm Working Length, 6/Box .....	C9991
2.9mm, Hooded, 7.6cm Working Length, 6/Box .....	C9990

## Curved Vortex Router

4.5mm, 45° Pre-Bent, 11.5cm Working Length, 6/Box.....	N9375
--	-------

## Otolaryngology Bur

4.0mm, Hooded, 10.8cm Working Length, 6/Box .....	N9390
---	-------



Ideal for less aggressive removal of hard bone, Ideal for rhinoplasty

## Rhinotec® Spherical Bur, Hooded

	Cat. No.
4.5mm, Hooded, 10.8cm Working Length, 6/Box .....	N9380
3.5mm, Hooded, 7.6cm Working Length, 6/Box .....	C9912
2.9mm, Hooded, 7.6cm Working Length, 6/ Box .....	C9911

## Rhinotec® Spherical Bur, Unhooded

3.5mm, Unhooded, 7.6cm Working Length, 6/Box.....	N9382
---	-------

## Rhinotec Spherical Diamond Bur, Hooded

3.5mm, Hooded, 10.8cm Working Length, 6/Box .....	N9385
---	-------



Ideal for aggressive removal of hard bone and cartilage



Ideal for less aggressive removal of hard bone and cartilage



Ideal for less aggressive removal of hard bone and cartilage

# E Burs

Indications for Use: Otology, Spine & Neuro



# E Burs

Indications for Use: Otology, Spine & Neuro

\*These burs may be used with multiple bur guard options to change the working length of the bur.

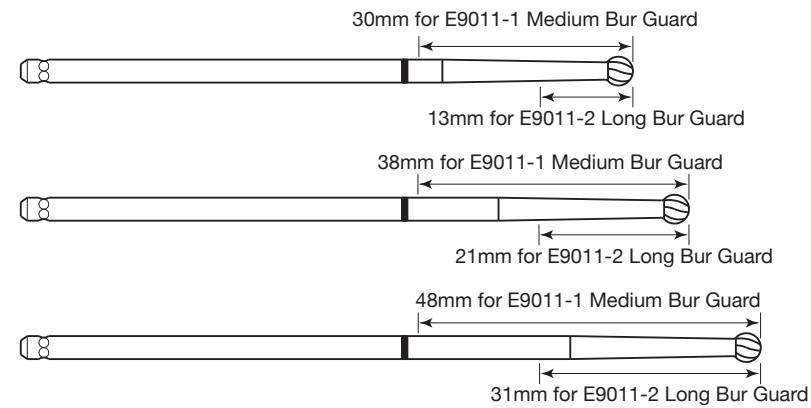

E9010 Bur Guard No.	Round Fluted						
	Flutes (mm)	4.00	4.00	6.00	6.00	6.00	8.00
E9011-1 or E9011-2	Diameter (mm)	0.50	0.70	1.00	1.50	2.00	2.50
E9011-1 or E9011-2			E8007	E8010	E8015	E8020	E8025
E9011-1 or E9011-2				E8110	E8115	E8120	E8125
E9011-1 or E9011-2		E8205	E8207	E8210	E8215	E8220	E8225

Bur Guard No.	LSO Round Fluted				
	Flutes (mm)	8.00	8.00	8.00	10.00
E9011-1 or E9011-2	Diameter (mm)	3.00	4.00	5.00	6.50
E9011-1 or E9011-2		E8030LSO	E8040LSO	E8050LSO	E8065LSO
E9011-1 or E9011-2		E8130LSO	E8140LSO	E8150LSO	E8165LSO
E9011-1 or E9011-2		E8230LSO	E8240LSO		E8265LSO

E9010 Bur Guard No.	Fine Round Diamond										
	Diameter (mm)	0.50	0.70	1.00	1.50	2.00	2.50	3.00	4.00	5.00	6.00
E9011-1 or E9011-2									E6040		
E9011-1 or E9011-2				E6110	E6115	E6120	E6125	E6130	E6140	E6150	E6160
E9011-1 or E9011-2		E6205	E6207	E6210	E6215	E6220	E6225	E6230	E6240	E6250	

E9010 Bur Guard No.	Coarse Round Diamond									
	Diameter (mm)	1.00	1.50	2.00	2.50	3.00	4.00	5.00	6.00	7.00
E9011-1 or E9011-2						E5160	E5140		E5130	E5170
E9011-1 or E9011-2		E5210	E5215	E5220	E5225	E5230	E5240	E5050		

\*These burs may be used with multiple bur guard options to change the working length of the bur.

E9010 Bur Guard No.	Wirepass burs		
	Diameter (mm)	1.00	1.50
E9011-1 or E9011-2	Length (mm)	38.00	38.00
E9011-1 or E9011-2		E4110	E4115

E9010 Bur Guard No.	Neuro Burs			
	Flutes (mm)	1.00	2.00	2.00
E9011-7 or 7020-017	Diameter (mm)	1.80	2.20	3.00
E9011-8 or 7020-018	Bur Head Length (mm)	11.00	16.00	25.00
E9011-7 or 7020-017			7021-713	
E9011-8 or 7020-018				7021-815
7020-019				7021-917

E9010 Bur Guard No.	Helical Bur for E9010 Drill	
E9011-9, E9011-2 and 7020-012	Bur Head Length (mm)	25.00
E9011-9, E9011-2 and 7020-012		7021-960

E9010 Bur Guard No.	E9010 Lindemann Bur	
E9011-1	Diameter (mm)	1.60
E9011-1	Bur Head Length (mm)	31.00
E9011-1		E4217

E9010 Bur Guard No.	E9010 Side Cutting Burs		
	Diameter (mm)	0.80	2.00
E9011-1	Bur Head Length (mm)	4.90	7.50
E9011-1		E4208	E4220

Products shown at actual size.





5052-012



5038-001



5038-002



5038-004



5038-005



5038-600

**Attachments & Accessories**

	Cat. No.
Standard Sterilization Case .....	5052-012

**Handpieces**

Osteon Handpiece, Straight.....	5038-001
---------------------------------	----------

Osteon Handpiece, Angled.....	5038-002
-------------------------------	----------

**Attachments & Accessories**

Osteon Footswitch with Hose .....	5038-004
-----------------------------------	----------

Osteon Hose .....	5038-005
-------------------	----------

Osteon Tubing Set with irrigation tip.....	5038-600
--	----------

Working Length (mm)	Fluted Round Burs											
	Diameter (mm)	4.00	6.00	6.00	6.00	6.00	8.00	8.00	8.00	10.00	10.00	
30									5056-116	5056-119	5056-118	5056-117
38									5056-128	5056-127	5056-126	5056-125
48		5056-165	5056-164	5056-140	5056-142		5056-149	5056-146	5056-145	5056-144		

Working Length (mm)	Fine Diamond Round Burs										
	Diameter (mm)	0.50	0.70	1.00	1.50	2.00	3.00	4.00	5.00	6.00	
30									5056-168	5056-147	5056-167
38									5056-148	5056-150	
48		5056-161	5056-160	5056-158	5056-163	5056-162	5056-159	5056-152			



### Handpieces

Cat. No.

### Attachments & Accessories

Standard Bur Extension, Short, use with standard Cebotome Burs .....	
Universal Hose, 10' (3.05m).....	5052-010

Cebotome® Burs								
Flutes (mm)	2.00	2.00	2.00	10.00	10.00	10.00	6.00	6.00
Diameter (mm)	5.00	6.00	7.00	7.00	8.00	9.00	8.50	10.00
	5052-181	5052-182	5052-183	5052-184	5052-185	5052-186	5052-187	5052-188

Cebotome Burs				
Flutes (mm)	6.00	10.00	6.00	8.00
Diameter (mm)	5.00	10.00	7.00	8.50
	5052-189	5052-190	5052-191	5052-192

Cebotome Diamond Metal Cutting Burs		
Diameter (mm)	3.2	3.2
Diamond	Flat	Round
	5052-144	5052-145

Cebotome Metal Cutting Wheels		
Grit (mm)	150.00	150.00
Diameter (mm)	25.40	25.40
	5052-125	5052-126

# Wires & Staples

Indication for Use: Small Bone Trauma



# Miscellaneous Accessories

## C-Wires

Cat. No.	Tip	Diameter	Length	Quantity
5050-041	Spade	.028" (.70mm)	5" (13.00cm)	50 per Pkg.
5050-042	Spade	.035" (.90mm)	5" (13.00cm)	50 per Pkg.
5050-043	Spade	.045" (1.10mm)	5" (13.00cm)	50 per Pkg.
5050-044	Spade	.062" (1.60mm)	5" (13.00cm)	50 per Pkg.
5050-046	Trocar	.028" (.70mm)	5" (13.00cm)	50 per Pkg.
5050-047	Trocar	.035" (.90mm)	5" (13.00cm)	50 per Pkg.
5050-048	Trocar	.045" (1.10mm)	5" (13.00cm)	50 per Pkg.
5050-049	Trocar	.062" (1.60mm)	5" (13.00cm)	50 per Pkg.

Note: To order C-Wires in a box of 5, instead of 50 per package, please order using catalog number 5050-2XX. For example, 5051-241 instead of 5050-041.

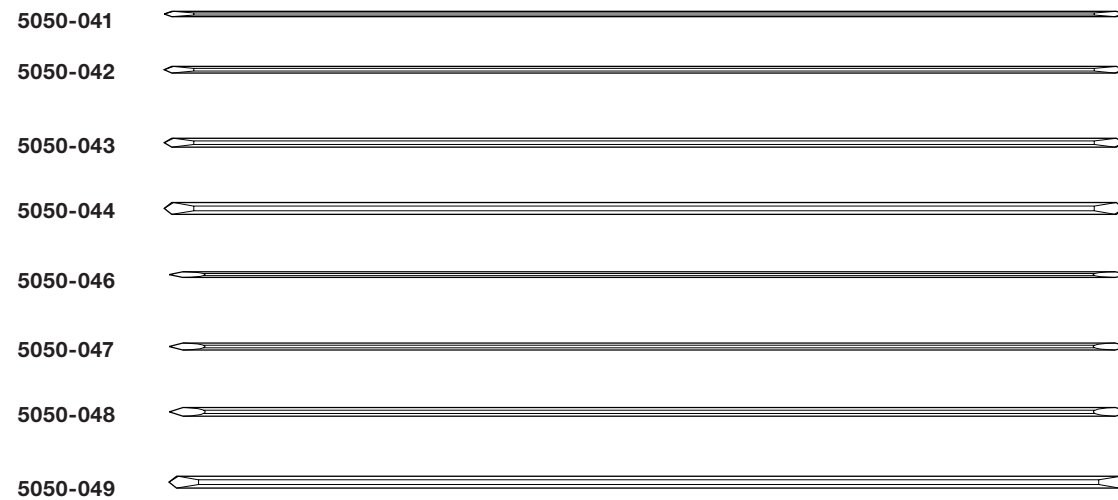

## Staplizer® Cartridges

Cat. No.	Width (mm)	Length (mm)
7707-03	7.00	7.00
7710-03	7.00	10.00
7007-03	10.00	7.00
7010-03	10.00	10.00
7015-03	10.00	15.00
7307-03	13.00	7.00
7310-03	13.00	10.00
7315-03	13.00	15.00
7320-03	13.00	20.00
7610-03	16.00	10.00
7615-03	16.00	15.00
7620-03	16.00	20.00
7625-03	16.00	25.00

Note: 3 cartridges per Pkg.  
5 Staples per cartridge.

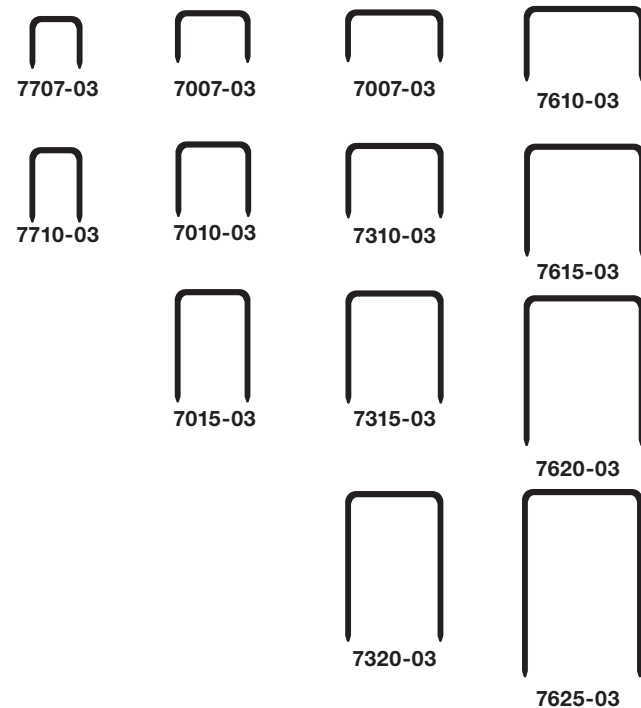

## Sterilization Containers

Standard Sterilization Case ..... 5052-012

Cat. No.

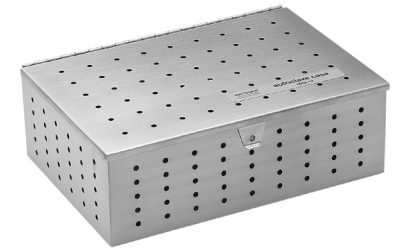

5052-012

## Holding Clamps for use with 5030-010 & 5030-020

Small ..... 5030-028



5030-029

5030-028

Bur Cleaning Brush ..... 1375-015



1375-015

Cleaning Brush for Cannulated Handpieces ..... 5053-124



5053-124



**D4000**



**D3000**



**E9000**

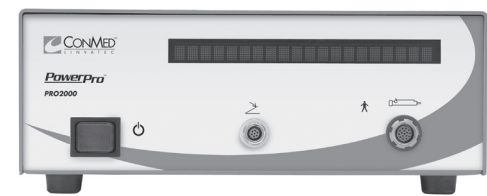

**PRO2000**

## Electric Consoles & Accessories

	Cat. No.
D4000 Console.....	D4000
D4000 Console with Irrigation .....	D4000A

Advantage® Console.....	D3000
-------------------------	-------

E9000® Console .....	E9000
----------------------	-------

PowerPro® Console .....	PRO2000
-------------------------	---------

	Cat. No.
2-Pedal Footswitch.....	5020-053

3-Pedal Footswitch.....	C9863
-------------------------	-------

Handpiece Cord.....	MC5057
---------------------	--------

Fluid Bag Support Rod for D3000 & E9000 .....	5040-180
---	----------

Console Stand.....	5020-054
--------------------	----------



**5020-053**

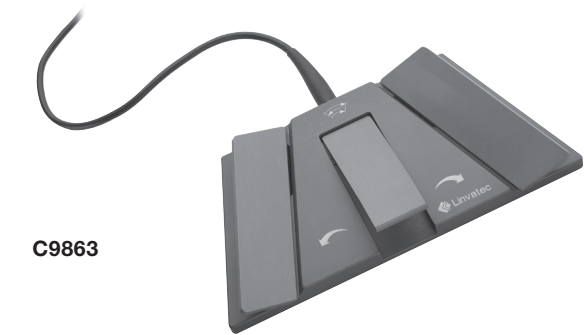

**C9863**



**MC5057**



**5040-180**

**5020-054**



1375-028

5052-010



Extension Hose  
5052-018

Hose for Staplizer®  
A201



M207

M208



M322

5144-002



1375-040

M105A



M317

1365-016

HALL® offers nitrogen specific products. Please contact customer service for information.

	Cat. No.
Micro 100™ Footswitch.....	1375-028
Universal Hose, 10' (3.05m) for HALL® Handpieces.....	5052-010

Extension Hose, 10' (3.05m), Male Schrader to Female Schrader.....	5052-018
Extension Hose, 10' (3.05m), Male Diss and Female Schrader (Not Shown).....	5052-029
10' (3.05m) Hose for Staplizer® Handpiece .....	A201

Regulator, Single Connection.....	M207
Regulator, Dual Connection.....	M208

DISS to Schrader Adapter .....	M322
Schrader Coupler.....	5144-002

Y Connector .....	1375-040
Blitz® Instrument Cleaner (Use with Staplizer Handpiece) .....	M105A

Instrument Lubricant for Staplizer.....	M317
HALL® Lubricant for Angled Attachments.....	1365-016

### Surgairtome Two® System Components Ordered Separately

	Cat. No.
Surgairtome Two Handpiece .....	5058-001
Medium Bur Guard .....	1375-012
Standard Sterilization Case .....	5052-012
Universal Hose, 10' (3.05m).....	5052-010
Bur Cleaning Brush.....	1375-015

### Ultrapower® Complete Drill System Product Listing

High Speed Drill.....	7020-001
Perforator Drive .....	7020-003
Universal Hose, 10' (3.05m).....	5052-010
Short Bur Guard like Midas-X, Red.....	7020-010
Medium Bur Guard like Midas-O, Copper .....	7020-011
Long Bur Guard like Midas-M/B, Mustard .....	7020-012
X-Long Bur Guard like Midas-AM/A, Lime .....	7020-013
Short Revision Extension like Midas TU, Teal .....	7020-014
Medium Revision Extension like Midas-R, Purple .....	7020-015
Short Bur Guard like Midas B-5, Black.....	7020-017
Medium Bur Guard like Midas B-1, Green.....	7020-018
Long Bur Guard like Midas S-1, Brown.....	7020-019
Key Wrench, 2 per box .....	7020-040
Footswitch.....	7020-045





**Ultrapower® Neuro/Spine Drill System Product Listing**  
Components Ordered Separately

	Cat. No.
High Speed Drill.....	7020-001
Perforator Drive.....	7020-003
Universal Hose, 10' (3.05m).....	5052-010
Short Bur Guard like Midas-X, Red.....	7020-010
Medium Bur Guard like Midas-O, Copper.....	7020-011
Long Bur Guard like Midas-M/B, Mustard.....	7020-012
X-Long Bur Guard like Midas-AM/A, Lime.....	7020-013
Short Bur Guard like Midas B-5, Black.....	7020-017
Medium Bur Guard like Midas B-1, Green.....	7020-018
Long Bur Guard like Midas S-1, Brown.....	7020-019
Key Wrench, 2 per box.....	7020-040
Footswitch.....	7020-045

**Ultrapower Basic Drill System Product Listing**  
Components Ordered Separately

High Speed Drill.....	7020-001
Universal Hose, 10' (3.05m).....	5052-010
Short Bur Guard like Midas-X, Red.....	7020-010
Medium Bur Guard like Midas-O, Copper.....	7020-011
Long Bur Guard like Midas-M/B, Mustard.....	7020-012
X-Long Bur Guard like Midas-AM/A, Lime.....	7020-013
Short Revision Extension like Midas TU, Teal.....	7020-014
Medium Revision Extension like Midas-R, Purple.....	7020-015
Short Bur Guard like Midas B-5, Black.....	7020-017
Medium Bur Guard like Midas B-1, Green.....	7020-018
Long Bur Guard like Midas S-1, Brown.....	7020-019
Key Wrench, 2 per box.....	7020-040
Footswitch.....	7020-045



**Osteon™/Ototome Burs**  
Components Ordered Separately

	Cat. No.
Round Carbide Bur, 6.5 x 30 mm, 2 each.....	5056-117
Round Carbide Bur, 5.0 x 30mm.....	5056-118
Round Carbide Bur, 4.0 x 30mm.....	5056-119
Round Carbide Bur, 5.0 x 38mm.....	5056-126
Round Steel Bur, 1.5 x 48mm.....	5056-140
Round Steel Bur, 2.0 x 48mm.....	5056-142
Round Carbide Bur, 4.0 x 48mm.....	5056-145
Round Carbide Bur, 3.0 x 48mm.....	5056-146
Round Diamond Bur, 4.0 x 48mm.....	5056-152
Round Diamond Bur, 1.0 x 48mm.....	5056-158
Round Diamond Bur, 3.0 x 48mm.....	5056-159
Round Diamond Bur, 0.5 x 48mm.....	5056-161
Round Diamond Bur, 2.0 x 48mm.....	5056-162
Round Steel Bur, 1.0 x 48mm.....	5056-164

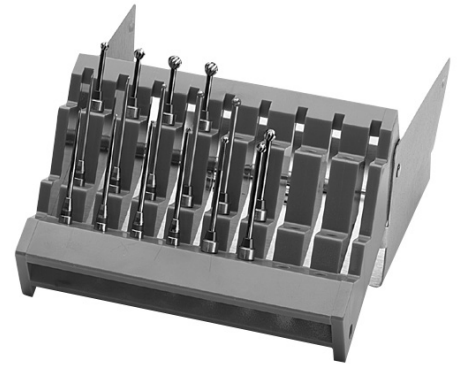

**Osteon Drill System with Burs**  
Components Ordered Separately

Bur Cleaning Brush.....	1375-015
Osteon Footswitch with Universal Hose 5052-010.....	5038-004
Osteon Hose.....	5038-005
Osteon Handpiece, Straight.....	5038-001
Osteon Handpiece, Angled.....	5038-002



**Revision Drill System**  
Components Ordered Separately

Universal Hose, 10' (3.05m).....	5052-010
Cebotome Bur Extension, Short.....	5052-042





### Cebotome Metal Cutting Wheel System

Components Ordered Separately

Cat. No.

Cebotome Metal Cutting Wheel.....	5052-125
Cebotome Metal Trimming Wheel.....	5052-126



### Cebotome Metal Cutting Bur System

Components Ordered Separately

ST Cebotome Metal Cutting Bur, Side, Flat.....	5052-144
ST Cebotome Metal Cutting Bur, Side, Round.....	5052-145



# HALL<sup>®</sup> Powered Instruments System Product Catalog

CONMED Corporation  
11311 Concept Blvd  
Largo, Florida 33773

Toll Free: 1-866-4CONMED  
International: 727-214-3000

[www.CONMED.com](http://www.CONMED.com)

**HALL<sup>®</sup>**  
POWERED INSTRUMENTS